

GTAKE

深圳市吉泰科驱动技术有限公司
江苏吉泰科电气股份有限公司

SHENZHEN GTAKE DRIVE TECHNOLOGY CO., LTD.
JIANGSU GTAKE ELECTRIC CO., LTD.

以客户为中心
Customer Focused

让控制更简单
Simplify Your Control



GTAKE

深圳市宝安区石岩塘头一号路中运泰科技工业园10栋
Building 10, Zhong-yun-tai Industrial Park, Tangtou Road No.1, Bao'an
District, Shenzhen, Guangdong Province
Tel: 86-0755-86392609 Fax: 86-0755-86392625



编码 Code: 34.05.0003
版本 Version: A04



www.gtake.com.cn

公司简介 | Company Profile



江苏吉泰科电气股份有限公司以自主知识产权的电力电子技术和电机控制技术为基础，致力于打造国际一流的技术平台，以行业内一流的产品和系统解决方案服务于国际、国内的中、高端客户。

公司专注于电力电子技术和电机控制技术，主要涵盖工业变频器、伺服驱动器、新能源汽车电机控制器、风力发电变流器和光伏逆变器产品的研发、生产和销售。

吉泰科一直致力于保护员工和用户的健康与安全，以及对环境保护的持续贡献。为此，公司产品全面执行欧盟RoHS指令，严格限制对人体和环境有害成分的使用，受到海内外用户的一致好评与尊重。

“以客户为中心”是吉泰科的核心价值观，吉泰科以追求客户对我们产品的信赖为己任，让客户享受我们的质量与服务，最终实现打破国外品牌的垄断，从国内走向国际的企业使命。公司在经营方面秉承自主创新、精诚团结的企业精神，采用现代化企业经营理念，利用现代化管理工具，使企业的业务流程规范、高效。

Jiangsu GTAKE Electric Co., Ltd., by virtue of advanced power electronic and motor control technology with independent intellectual property rights, is committed to providing first rank products and system solutions derived from our internationalized technology platform, for medium and high-end customers worldwide.

GTAKE focusing on power electronic and motor control technology is dedicated to R&D, production and sales of industrial AC motor drives, servo drives, new energy vehicle motor controllers, wind power converters, solar converters, etc.

GTAKE has always been committed to protecting health & safety of employees & users and continuing contribution to environmental protection. To this end, GTAKE fully conforms to EU RoHS directive for all products, strictly limits the use of harmful ingredients to human and environment, thus receiving unanimous praise and respect from domestic and overseas users.

With the core value "customer focused", we are in unremitting pursuit of customers trust by providing high-quality products and professional services. GTAKE resolves to break the monopoly of top alien brands in demanding applications, with our strong and vigorous steps in market deployment worldwide. We are adopting scientific principles, utilizing advanced management tools, to facilitate our business process standardized, and efficient, in the spirit of innovation and all staff solidarity.

企业历程 | Enterprise History

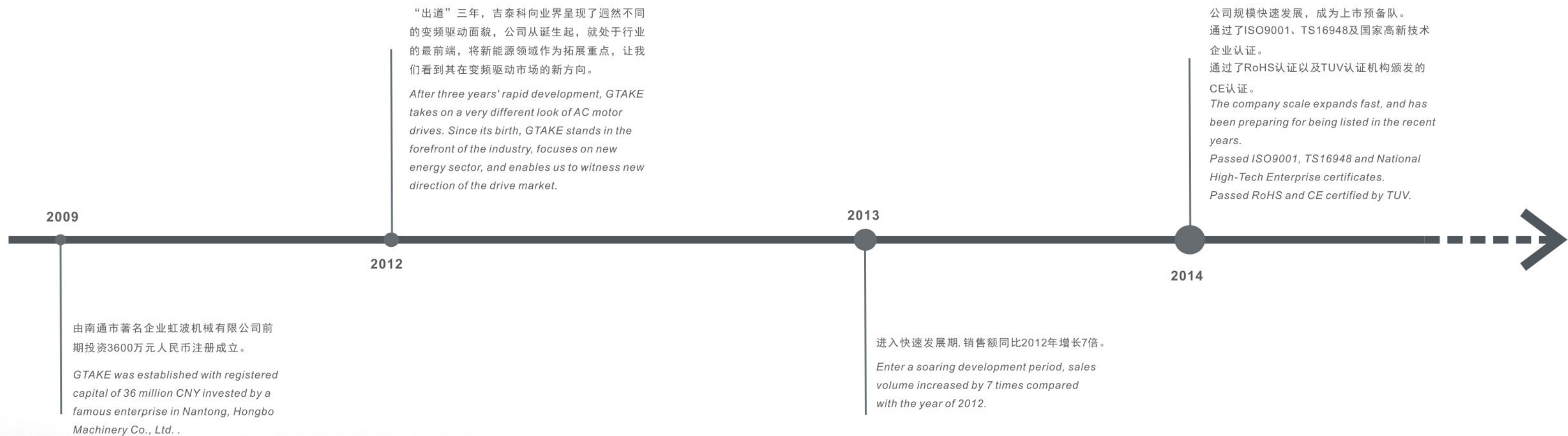

产品特点

Products Features



GK800系列驱动器

GK800 Series High Performance AC Motor Drives

支持同步电机和异步电机驱动
Synchronous and asynchronous motor supported

有速度传感器和无速度传感器矢量控制
Speed-sensor control and speed-sensorless control programmable

位置控制、速度控制和转矩控制
Position control, speed control and torque control programmable



新能源汽车电机控制器

New Energy Vehicle Motor Controllers

支持同步电机和异步电机驱动
Synchronous and asynchronous motor supported

风冷和水冷可选
Forced air cooling and water cooling optional

防护等级最高可达IP67
IP67 rated

GK600系列变频器

GK600 Series General Purpose AC Motor Drives

无速度传感器矢量控制
Speed-sensorless control



GK500系列迷你型变频器

GK500 Series Mini AC Motor Drives

小功率V/F控制，低速高转矩
Small power rating V/F control, strong torque at low frequency



ES101系列节能一体柜

ES101 Series Energy Saving Cabinet Drives

异步注塑机专用
Dedicated AC motor drives for asynchronous injection molding machine

GK1000系列AFE能量回馈型变频器

GK1000 Series AFE Energy Feedback AC Motor Drives

四象限运行，能量实时回馈电网
Four-quadrant running. Real-time energy feedback



产品特点

Products Features

采用美国TI公司新一代电机控制专用数字信号处理器 (DSP)，主频达到150MHz。

TI latest motor-control specific digital signal processors (DSP) with clock frequency reaching up to 150Hz are adopted.

采用德国Infineon第四代IGBT模块，结合其175°C最高结温特性，运用创新型的PWM调制方式，进一步降低了开关损耗。

As Infineon 4th generation IGBTs featured with maximum junction temperature up to 175°C are adopted, coupled with our innovative PWM modulation techniques, switch losses are remarkably reduced.

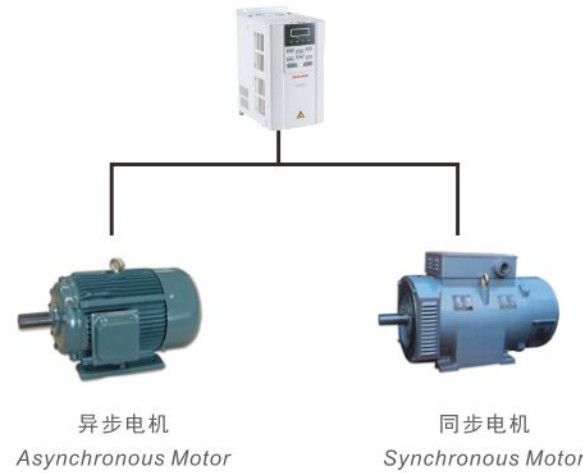

支持异步电机和永磁同步电机驱动，对异步电机和永磁同步电机的参数进行精准辨识。可以设定两组电机参数，允许驱动器在两台不同的电机之间切换控制，切换功能可以由功能码或多功能端子设定。

Asynchronous motors and permanent magnet synchronous motors control are supported, with accurate autotuning. Two independent motor profiles are programmed, and the switchover of the two motors' control can be realized by parameter setting or terminal input.

V/F控制模式下，高精度的电流限定控制，使得驱动器无论是快速加减速还是堵转，都不会出现过电流报警，可靠地保护驱动器；矢量控制模式下，高精度的转矩限定控制，使得驱动器可以按用户工艺控制要求，输出强劲的转矩或柔和的转矩，可靠地保护机械设备。

In V/F control mode, accurate current limited control function makes sure of no over-current fault occurred no matter the drives are running at acceleration/deceleration, or rotor locked status, well protecting the drives. In vector control mode, accurate torque limited control pledges powerful or moderate torque complying with application requirements, protecting machinery well.

V/F分离控制模式下，输出频率和输出电压可以分别设定，适用于变频电源、力矩电机控制等应用场合。

In V/F separated control mode, output frequency and output voltage can be set respectively, fit for applications, such as variable frequency power sources, torque motors, etc.

控制模式 Control pattern	启动转矩 Starting torque	调速范围 Speed range	速度精度 Speed accuracy	转矩响应 Torque response
V/f控制 V/f control	0.5Hz 180%	1:100	±0.5%	
无PG矢量控制1 Speed-sensorless control 1	0.5Hz 180%	1:100	±0.2%	<10ms
无PG矢量控制2 Speed-sensorless control 2	0.25Hz 180%	1:200	±0.2%	<10ms
有PG矢量控制 Speed-sensor control	0Hz 200%	1:1000	±0.02%	<5ms

智能扩展口，允许同时接入两块扩展卡，满足用户实现行业特殊控制需求。

Intelligent expansion interfaces allow two expansion boards inserted at the same time, meeting demand of some specific applications.

编码器的安装位置不在电机的轴端时，只要该轴与电机轴之间保持固定的减速比，也能进行有PG矢量控制。

When the encoder is not mounted to the motor shaft directly, speed-sensor control can still be done as long as reduction ratio of detected shaft to motor shaft is correctly set.

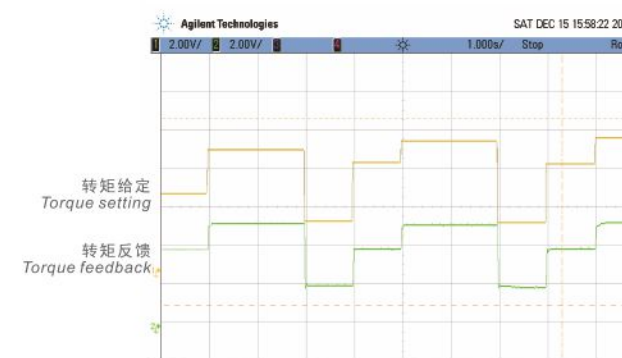

产品特点

Products Features

在有PG矢量控制方式下，可进行零伺服、主轴定向（4个定向位置）、简易进位控制（8种进位量设置）、脉冲列位置控制等几种位置控制模式。

In speed-sensor control pattern, zero servo, motor spindle orientation (4 orientational positions programmable) control, simple feed control (8 feeds programmable), and pulse train position control can be performed.

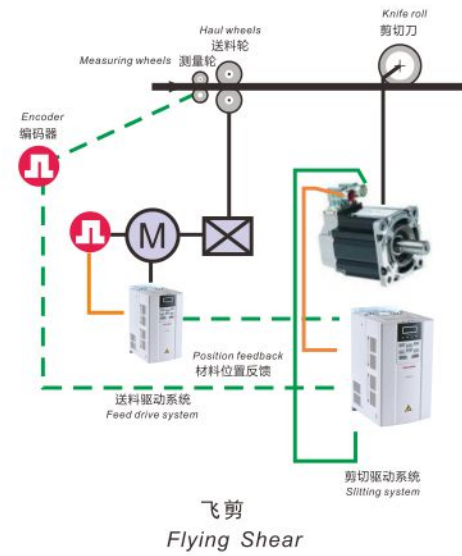
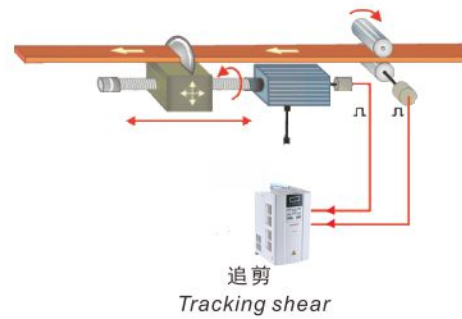

灵活的频率给定方式，支持各种主、辅给定以及切换。

Abundant frequency command sources. Various master, auxiliary command patterns and switchover supported.

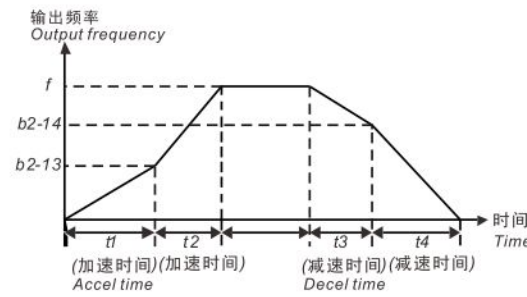

具有多种加、减速曲线的选择，如：直线加减速、折线加减速、3种S曲线加减速。

Multi-Accel/Decel modes: linear, broken line, three kinds of S-curve.

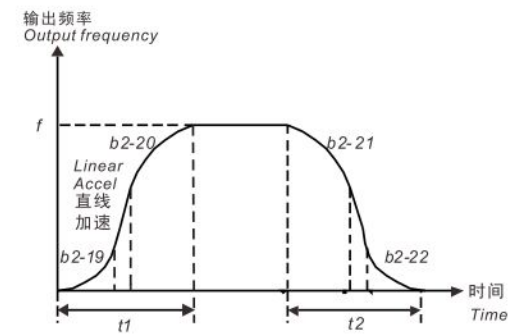

不依赖硬件的速度搜索启动功能，速度搜索准确、可靠，能对正在旋转中的电机进行无冲击的平滑启动。

Accurate and reliable flying start function assures smooth restart of rotary motors.

具有本机参数备份及通过操作面板进行参数上传和下载功能，方便调试和参数恢复。

Supports parameters back-up setting to ensure efficient upload, download, testing and recovery of the parameters.

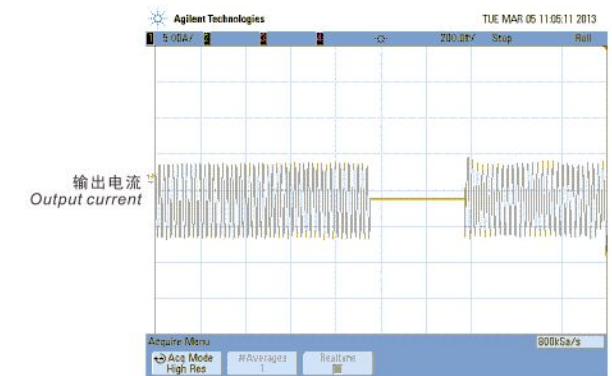

速度搜索启动
Flying start

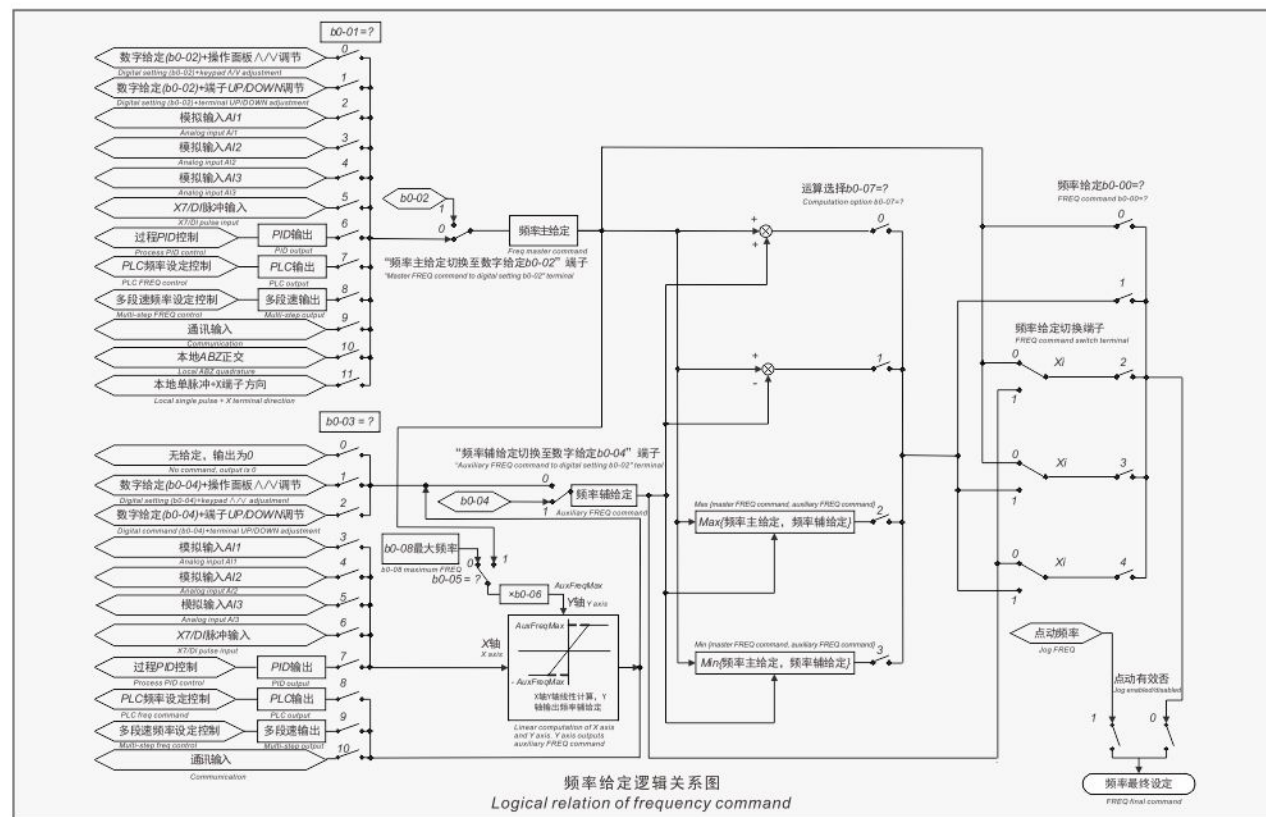

产品特点 | Products Features

过程PID控制，具有丰富的给定和反馈方式，两组比例、积分和微分参数自由切换，可选择正作用和反作用特性。

Process PID control has abundant set and feedback sources, with two group parameters of proportional, integral, and differential programmable, positive and negative adjustment programmable.

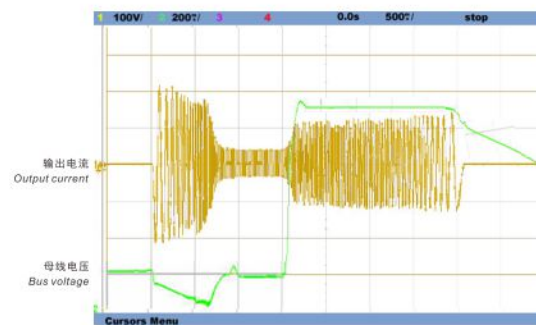

过压抑制
Overvoltage suppression

过压失速保护：大惯性负载减速运行过程中有短时再生制动时，通过对输出频率的瞬时调整，从而降低过压跳闸的几率，保证系统的连续可靠运行。

Over voltage stall protection: when driving a big inertia load, it is likely to produce regenerated energy in course of Decel. By adjusting the output frequency momentarily, the probability of over voltage trip will be reduced, pledging the system consecutive running.

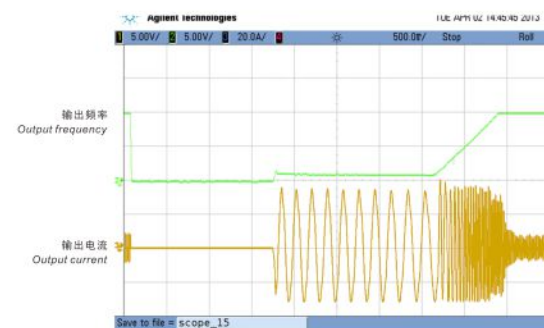

逐波限流
Cycle-by-cycle current limit

支持直流电源的输入，方便用户组成共直流母线的应用方案。

DC power supply input supported. Common DC bus solution supported.

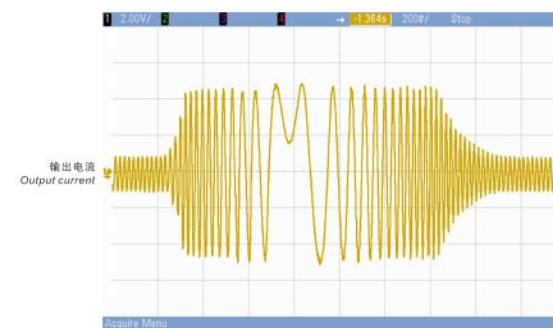

正反转切换(加减速时间0.1s)
Transition of forward/reverse run (Decel/Accel time: 0.1s)

所有单板有涂层防护，适应污染等级较高的应用场合。

Conformal coating well protects the drives against harsh environment.

采用计算机热仿真的方法，分析各监控点温度，通过风流速度场图和温度场图，估算出产品内部最高温升，为产品的合理结构提供了量化的依据。

Computer-aid thermal simulation techniques are adopted in course of structure design. Temperature rise of the highest temperature points are well estimated by adopting airflow and temperature field simulation, providing scientific criteria for optimal structure layout.

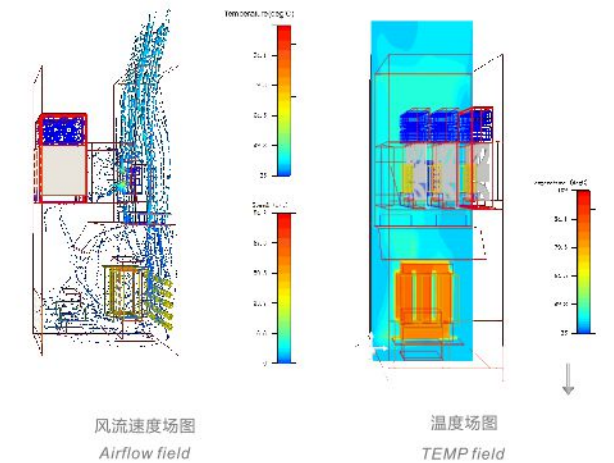

欠电压调节：在瞬时欠压或瞬时停电时，通过自动降低输出频率，维持直流母线电压的恒定，从而保证驱动器短时间内的连续运行，适合风机、离心泵等应用场合。

Undervoltage adjustment: when momentary undervoltage or momentary power loss occurs, dynamically reducing output frequency moderately will maintain the stability of DC bus voltage in short time, which usually applies to applications, like fans, centrifugal pumps, etc.

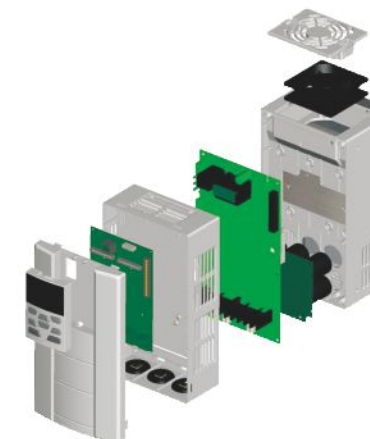

逐波限流功能，负载突变时，避免变频器频繁跳闸。

Cycle-by-cycle current limit function reduces trips at jumpy load.











直流接触器断电保护功能，避免上电后因直流接触器触点异常断开而损坏上电缓冲电阻。

DC contactor power-off protection refrains from the damage of power-on buffer resistor resulted from contact abnormality of the DC contactor after applying power.

产品特点

Products Features

							
EPC-PG1	EPC-PG2	EPC-PG3	EPC-PG4	EPC-PG5	EPC-PG6	EPC-PG8	EPC-PG9
<p>适配：ABZ集电极开路型/推挽型编码器 分频输出：ABZ集电极开路型 电源：12/24V 接线方式：端子接线</p> <p><i>Applicable: A/B/Z open collect/push-pull encoder Frequency dividing output: A/B/Z open collector Power: 12/24V Wiring method: terminal wiring</i></p>	<p>适配：ABZ差分类型编码器 分频输出：ABZ差分类型输出 电源：5V 接线方式：端子接线</p> <p><i>Applicable: A/B/Z differential encoder Frequency dividing output: A/B/Z differential type output Power: 5V Wiring method: terminal wiring</i></p>	<p>适配：UVW类型编码器 电源：5V 接线方式：端子接线</p> <p><i>Applicable: UVW encoder Power: 5V Wiring method: terminal wiring</i></p>	<p>适配：旋转变压器类型编码器 电源：7V 接线方式：DB15接头</p> <p><i>Applicable: resolver signal input Power: 7V Wiring method: Db15 connector</i></p>	<p>适配：Sincos编码器类型 电源：5V 接线方式：DB15接头</p> <p><i>Applicable: SINCOS encoder Power: 5V Wiring method: DB15 connector</i></p>	<p>适配：旋转变压器类型编码器 分频输出：5V推挽输出 电源：7V 其它功能：扩展两路模拟量输入（EA11\EA12，其中EA11可作为电机温度输入）；包含CAN通讯功能。 接线方式：DB15接头</p> <p><i>Applicable: resolver signal input Frequency dividing output: 5V push-pull output Power: 7V Other functions: two expanded analog inputs(EA11/EA12, in which, EA11 can be motor temperature input). Including CAN communication function. Wiring method: DB15 connector</i></p>	<p>适配：ABZ差分类型编码器 分频输出：ABZ集电极开路 电源：5V 接线方式：端子接线</p> <p><i>Applicable: A/B/Z differential encoder Frequency dividing output: A/B/Z open collector Power: 5V Wiring method: terminal wiring</i></p>	<p>支持旋转变压器； 支持两路模拟量输入； 支持A/B/Z信号的开路集电极输出； 支持A/B/Z信号的差分输出。</p> <p><i>Supports resolver signal input. Supports two expanded analog inputs. Supports A/B/Z open collector signal output. Supports A/B/Z differential signal output.</i></p>

									
EPC-CM1	EPC-CM2	EPC-CM3	EPC-TM1	EPC-TM2	EPC-VD1	EPC-VD2	EPC-IM1	EPC-IM2	EPC-RT1
<p>支持232通讯扩展和CAN通讯扩展</p> <p><i>Supports expanded 232 communication and CAN communication (CAN only for GK800 series)</i></p>	<p>PROFIBUS-DP通讯适配卡</p> <p><i>PROFIBUS-DP communication board</i></p>	<p>CANOPEN通讯适配卡</p> <p><i>CANOPEN communication board</i></p>	<p>支持1路模拟量输入和1路开关量输入，1路模拟量输出和1组继电器输出。</p> <p><i>Supports one analog input, one digital input, one analog output, and one relay output.</i></p>	<p>支持2路PT100温度检测； 支持2路模拟量输出； 支持2路开关量输入； 支持2组继电器输出。</p> <p><i>Supports 2 PT100 temperature detection. 2 analog outputs. 2 digital outputs. and 2 relay outputs.</i></p>	<p>支持输入电压、输出电压检测。</p> <p><i>Supports detection of input voltage, output voltage.</i></p>	<p>支持输出电压检测实现转速跟踪功能； 支持母线电压检测。</p> <p><i>Supports output voltage detection, realizing revolving speed track. Supports bus voltage detection.</i></p>	<p>支持两路模拟量输入，电压或电流输入可选； 电流输入范围：0A~1A； 电压输入范围：0V~24V。</p> <p><i>Supports 2 analog input, voltage or current input optional. Current input range: 0A-1A. Voltage input range: 0V-24V.</i></p>	<p>支持两路电流模拟量输入，范围：0~1A。</p> <p><i>Supports 2 current analog inputs, range: 0-1A.</i></p>	<p>支持实时时钟输入； 1路模拟量输出； 1组继电器输出。</p> <p><i>Supports real-time clock input. 1 analog output. 1 relay output.</i></p>

产品特点

Products Features

GK800产品型号命名规则

GK800 Model Explanation

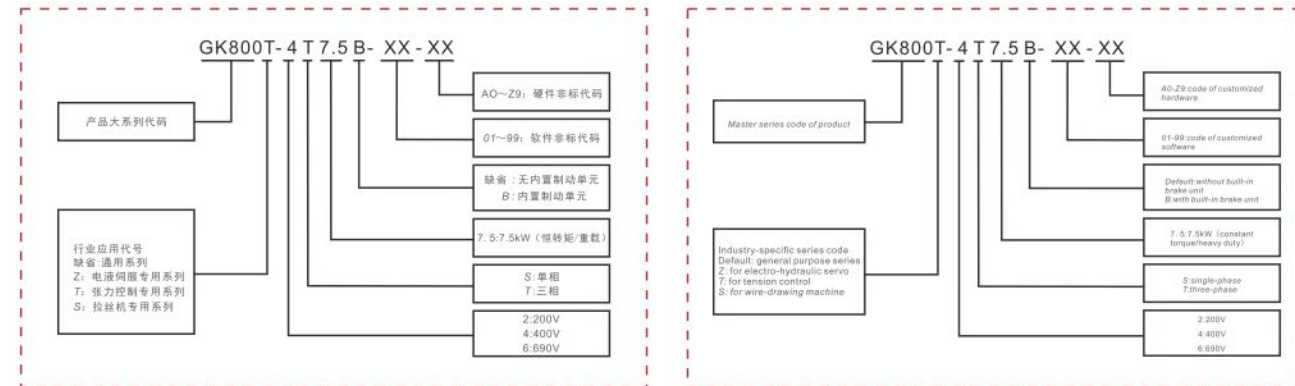

GK800产品型号及技术数据

Model Information of GK800 Series

产品型号 Model	功率等级(kW) Power rating	输出电流(A) Output current	输入电流(A) Input current	适配电机(kW) Applicable motor	制动单元 Brake unit
GK800-4T1.5B	1.5	3.8	5.0	1.5	标准内置 Inbuilt
GK800-4T2.2B	2.2	5.5	6.0	2.2	
GK800-4T3.7B	3.7	9.0	10.5	3.7	
GK800-4T5.5B	5.5	13	14.6	5.5	
GK800-4T7.5B	7.5	17	20.5	7.5	
GK800-4T11B	11	24	29	11	
GK800-4T15B	15	30	35	15	

产品型号 Model	功率等级(kW) Power rating	输出电流(A) Output current	输入电流(A) Input current	适配电机(kW) Applicable motor	制动单元 Brake unit
GK800-4T18.5(B)*	18.5	39	44	18.5	内置可选 Inbuilt optional
GK800-4T22(B)*	22	45	50	22	
GK800-4T30(B)*	30	60	65	30	
GK800-4T37(B)*	37	75	80	37	
GK800-4T45(B)*	45	91	95	45	
GK800-4T55(B)*	55	112	118	55	
GK800-4T75(B)*	75	150	157	75	

产品型号 Model	功率等级(kW) Power rating	输出电流(A) Output current	输入电流(A) Input current	适配电机(kW) Applicable motor	制动单元 Brake unit
GK800-4T90	90	176	160**	90	外置 External optional
GK800-4T110	110	210	192**	110	
GK800-4T132	132	253	232**	132	
GK800-4T160	160	310	285**	160	
GK800-4T185	185	350	326**	185	
GK800-4T200	200	380	354**	200	
GK800-4T220	220	430	403**	220	
GK800-4T250	250	470	441**	250	
GK800-4T280	280	520	489**	280	
GK800-4T315	315	590	571**	315	
GK800-4T355	355	650	624**	355	
GK800-4T400	400	725	699**	400	
GK800-4T450	450	820	790**	450	
GK800-4T500	500	860	835**	500	
GK800-4T560	560	950	920**	560	
GK800-4T630	630	1100	1050**	630	

* 表示该功率等级变频器制动单元可选内置；以18.5为例：不带制动单元型号为GK800-4T18.5，带制动单元型号为GK800-4T18.5B。制动电阻需外配。

** 配置直流电抗器后的输入电流，90kW~500kW产品出厂配置外置直流电抗器，请务必将电抗器接入使用，否则会导致产品不能正常运行；560kW和630kW产品为柜式安装，内置直流电抗器和交流输出电抗器。

* Means brake unit is optionally inbuilt. Take 18.5 for example: the model without brake unit is GK800-4T18.5, and the model with brake unit is GK800-4T18.5B. Brake resistor needs to be mounted externally.

** Means the rated input current with the configuration of a DC reactor. The drives with 90kw~500kw are provided with externally mounted DC reactors as default. Be sure to connect the reactors and failure to comply may result in abnormal running. The 560kw and 630kw drives are cabinet structured with internally mounted DC reactors and AC output reactors.

GK800技术规格

Technical Features of GK800

功率输入 Power input

额定电压 Rated input voltage	额定输入电流 Rated input current	频率 Frequency	允许电压范围 Allowable voltage range
3相380VAC/400VAC/415VAC/ 440VAC/460VAC/480VAC	参见GK800产品型号及技术数据表	50Hz/60Hz, 允许频率波动范围±5%。	电压持续波动±10%，短暂波动-15%~+10%，即 323V~528V， 电压不平衡率<3%，畸变率满足IEC61800-2要求。
3-phase 380VAC/400VAC/415VAC/ 440VAC/460VAC/480VAC	See the table "Model information of GK800 series"	50Hz/60Hz, tolerance ±5%.	Voltage consecutive fluctuation ±10%, short fluctuation -15%~+10%, i.e. 323V~528V, Voltage out-of-balance rate: <3%, THD meets the standards of IEC61800-2.

功率输出 Power output

标准适用电机 Applicable motor	额定电流 Rated current	输出电压 Output voltage	输出频率 Output frequency	过载能力 Over load capability
参见GK800产品型号及技术 数据表	参见GK800产品型号及 技术数据表	3相：0~额定输入电压， 误差小于±3%。	0.00Hz~600Hz， 单位0.01Hz。	150% 1分钟；180% 10秒；200% 0.5秒，间隔 10分钟。
See the table "Model information of GK800 series"	See the table "Model information of GK800 series"	3-phase: 0~rated input voltage, error less than ±3%.	0.00Hz~600Hz, Resolution 0.01Hz.	150% 1min. 180% 10s. 200% 0.5s, once per 10 mins.

产品特点

Products Features

运行控制特性 Control characteristics				
控制方式 Control pattern	V/F控制 V/F control	无PG矢量控制1 Speed-sensorless control 1	无PG矢量控制2 Speed-sensorless control 2	有PG矢量控制简易位置控制 Speed-sensor control Position control
启动转矩 Starting torque	0.5Hz 180%	0.5Hz 180%	0.25Hz 180%	0Hz 200%
调速范围 Speed range	1:100	1:100	1:200	1:1000
稳速精度 Speed accuracy	±0.5%	±0.2%	±0.2%	±0.02%
速度波动 Speed ripple	—	±0.3%	±0.3%	±0.1%
转矩控制 Torque control	无 No	无 No	有 Yes	有 Yes
转矩精度 Torque accuracy	—	—	±7.5%	±5%
转矩响应时间 Torque response	—	<10ms	<10ms	<5ms
定位精度 Positioning accuracy	—	—	—	±1线脉冲 ±1 pulse

基本功能 Basic functions	
启动频率 Start frequency	0.00Hz~600.00Hz
加减速时间 Accel/Decel time	0.00s~60000s
载波频率 Carrier frequency	0.7kHz~16kHz
频率设定方式 Frequency command modes	数字设定+操作面板Up/Down; 数字设定+端子Up/Down设定; 上位机通讯设定; 模拟设定: A11/A12/A13; 端子脉冲设定。 Digital setting +Keypad Up/Down; Digital setting+terminal Up/Down. Communication setting. Analog setting:A11/A12/A13. Terminal pulse setting.
启动方式 Start methods	从启动频率启动; 先直流制动再起; 速度搜索启动。 Start from starting frequency. DC injection braking at start; Flying start.
停机方式 Stop methods	减速停机; 自由停车; 减速停机+直流制动。 Ramp to stop. Coast to stop. DC injection braking at ramp stop.
能耗制动能力 Dynamic brake capability	制动单元动作电压: 650V~750V; 使用时间0.0s~100.0s; GK800-4T75及以下制动单元可内置。 Braking unit triggered voltage: 650~750V. Service time: 0.0s~100.0s. Brake units of GK800-4T75 and below are optionally inbuilt
直流制动能力 DC braking capability	直流制动起始频率: 0.00Hz~600.00Hz; 直流制动电流: 恒转矩0.0%~100%; 直流制动时间: 0.0s~30.00s。 DC braking start frequency: 0.00Hz~600.00Hz. DC braking current: constant torque 0.0%~100.0%. DC braking time: 0.0s~30.00s.
输入端子 Input terminals	七个开关量输入端子, 其中一个可作高速脉冲输入。支持干节点、有源PNP、NPN输入方式; 三个模拟量输入端子, 其中一个只能用作电压输入, 另两个电压电流可选。 Seven digital input terminals, one of them can be used for pulse input. Support dry contact, active PNP and NPN input. Three analog input terminals, one of them is voltage only, and the other two are voltage/current programmable.
输出端子 Output terminals	一个高速脉冲输出端子(0kHz~50kHz的方波信号输出), 两个模拟量输出端子(电压电流分别可选), 可实现设定频率、输出频率等物理量的输出; 一个开关量输出端子; 两组继电器输出端子。 One high-speed pulse output (0kHz~50kHz square wave signal output), and two analog outputs (voltage/current programmable), can output signals such as command frequency, output frequency, etc. One digital output. Two relay outputs.
编码器信号端子 Encode input terminal	支持5V/12V电压等级; 支持开路集电极、推挽和差分等不同类型的编码器信号输入。 Support 5V/12V power supply. Support OC, push-pull, differential signal inputs and such.

特色功能

Characteristic functions

参数拷贝、参数备份、共直流母线、两组电机参数自由切换、灵活的功能码显示和隐藏、各种主辅给定以及切换、可靠的速度搜索、多种加减速曲线选择、模拟量自动校正、抱闸控制、最多可支持16段速运行(两段速支持灵活的频率给定方式)、摆频控制运行、定长控制、计数、三组故障记录、过励磁制动、过压失速、欠电压调节、掉电再启动、频率跳跃、频率绑定、四段加减速时间自由切换、电机温度保护、灵活的风扇控制、过程PID控制、简易PLC控制, 灵活的多功能键设置、下垂控制、异步机和同步机的参数辨识、弱磁控制、高精度的转矩限定、V/F分离控制、无PG转矩控制、有PG转矩控制、两路编码器信号输入(支持增量式、UVW混合式、旋转变压器等速度反馈形式)、灵活的减速比控制、零伺服、定向控制、简易进位控制、脉冲列位置控制。

Parameter copy, parameter backup, common DC bus, two motors profiles programmable, flexible parameter display & hiding, various master & auxiliary command and switchover, reliable speed search started, a variety of Accel/Decel curves programmable, autocorrection of analog, contracting brake control, 16-step speed control programmable (2 steps support flexible frequency command), wobble frequency control, fixed length control, count function, three faults history, over excitation brake, overvoltage stall protection programmable, undervoltage stall protection programmable, restart upon power loss, skip frequency, frequency binding, four kinds of Accel/Decel time, motor thermal protection, flexible fan control, process PID control, simple PLC, multi-functional key programmable, droop control, asynchronous and synchronous motor parameters autotune, field weakening control, high-precision torque control, V/f separated control, torque control at speed-sensorless control, torque control at speed-sensor control, two encoders signal inputs (support incremental, UVW and resolver, etc.), flexible deceleration ratio control, zero servo, spindle orientation, simple feed control, pulse train position control.

保护功能 Protection	参见GK800说明书第七章故障诊断 Refer to "Chapter 7 Troubleshooting" in user manual of GK800 series
-----------------	--

环境 Environment					
使用场所 Field	海拔高度 Altitude	环境温度 Temperature	湿度 Humidity	振动 Vibration	存储温度 Storage temperature
室内, 不受阳光直射, 无尘埃、腐蚀性气体、油雾、水蒸气、滴水或盐分等。 Indoors, no direct sunlight, free from dust, corrosive gases, flammable gases, oil mist, water vapor, water drop, salt, etc.	0m~2000m: 1000m以上降额使用, 每升高100m, 额定输出电流减少1%。 0m~2000m: de-rate 1% for every 100m when above 1000 meters.	-10°C~+40°C, 40°C~50°C之间降额使用, 每升高1°C, 额定输出电流减少1%。 -10°C~+40°C, 40°C~50°C: rated output current de-rates 1% for every 1°C.	5%~95%, 不允许凝露。 5%~95%, no condensation.	小于5.9m/s ² (0.6g) Less than 5.9m/s ² (0.6g)	-40°C~+70°C

产品特点

Products Features

其它 Others			
效率 Efficiency	安装方式 Installation	防护等级 Protection grade	冷却方式 Cooling method
额定功率时, 7.5kW及以下功率等级: ≥93%; 11kW~45kW功率等级: ≥95%; 55kW以上功率等级: ≥98%。 At rated power, 7.5kW and below: ≥93%. 11kW~ 45kW: ≥95%; 55kW and above: ≥98%.	壁挂式(500kW及以下) 柜式(560kW和630kW) Wall-mounted type(500kW and below) Cabinet type(560kW and 630kW)	IP20	强迫风冷 Forced air cooling

GK800产品外形和安装尺寸

External dimensions of GK800

产品型号 Model	外形和安装尺寸(mm) External dimensions							重量(kg) Weight
	W	H	D	W1	H1	H2	安装孔直径 Mounting hole dia.	
GK800-4T1.5B	120	245	169	80	233	220	5.5	2.6
GK800-4T2.2B								
GK800-4T3.7B								
GK800-4T5.5B	145	280	179	105	268	255	5.5	3.9
GK800-4T7.5B								
GK800-4T11B	190	365	187	120	353	335	6	6.2
GK800-4T15B								
GK800-4T18.5(B)	270	475	220	170	460	435	8	15.5
GK800-4T22(B)								
GK800-4T30(B)								
GK800-4T37(B)	320	568	239	220	544	515	10	24
GK800-4T45(B)								
GK800-4T55(B)	385	670	261	260	640	600	12	37
GK800-4T75(B)								
GK800-4T90	395	785	291	260	750	705	12	50
GK800-4T110								
GK800-4T132	440	900	356	300	865	820	14	66
GK800-4T160								
GK800-4T185								
GK800-4T200	500	990	368	360	950	900	14	88
GK800-4T220								
GK800-4T250	650	1040	406	400	1000	950	14	123
GK800-4T280								
GK800-4T315								
GK800-4T355	815	1300	428	600	1252	1200	14	165
GK800-4T400								
GK800-4T450								
GK800-4T500								
GK800-4T560								
GK800-4T630								
	1100	2000	550	/	/	/	/	515

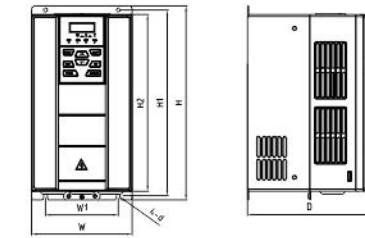

a) GK800-4T1.5B-GK800-4T15B

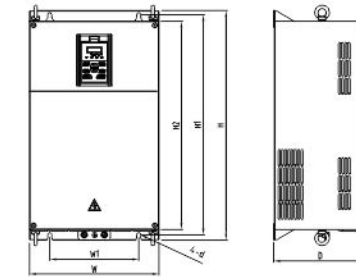

b) GK800-4T18.5(B)-GK800-4T75(B)

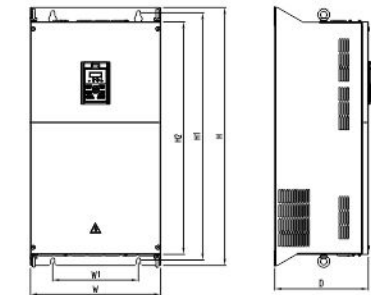

c) GK800-4T90-GK800-4T160

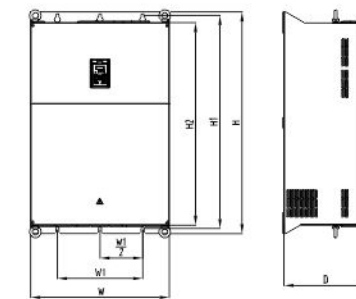

d) GK800-4T185-GK800-4T500

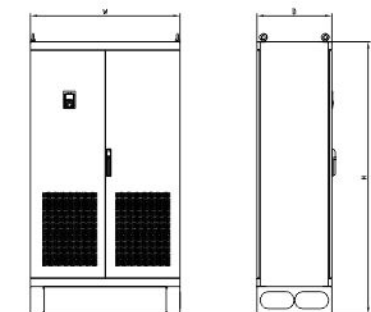

e) GK800-4T560-GK800-4T630

产品特点

Products Features

GK800控制端子功能说明

Specification of GK800 Control Terminals

类别 Category	模拟量输入 Analog input	技术规格 Specification
端子符号 Terminal	端子名称 Terminal designation	技术规格 Specification
+10V	模拟量输入参考电压 Analog input reference voltage	电压: 10.3V±3%, 最大输出电流25mA, 即外接电位器时需大于400Ω的电位器。 Voltage: 10.3V±3%, Maximum output current: 25mA, and resistance of external potentiometer should be larger than 400Ω.
GND	模拟地 Analog ground	内部与COM隔离 Isolated from COM interiorly
AI1	模拟量输入1 Analog input 1	0mA~20mA: 输入阻抗500Ω, 最大输入电流25mA。 0V~10V: 输入阻抗22kΩ, 最大输入电压12.5V。 通过跳线开关S2实现0mA~20mA与0V~10V模拟量输入的切换, 出厂默认电压输入。 0mA~20mA: input impedance 500Ω, maximum input current 25mA. 0V~10V: input impedance 22kΩ, maximum input voltage 12.5V. 0mA~20mA/0V~10V programmable by switch S2. Factory default: 0~10V.
AI2	模拟量输入2 Analog input 2	0mA~20mA: 输入阻抗500Ω, 最大输入电流25mA。 0V~10V: 输入阻抗22kΩ, 最大输入电压12.5V。 通过跳线开关S3实现0mA~20mA与0V~10V模拟量输入的切换, 出厂默认电压输入。 通过跳线开关S4实现直接检测电机温度模拟量输入。 0mA~20mA: input impedance 500Ω, maximum input current 25mA. 0V~10V: input impedance 22kΩ, maximum input voltage 12.5V. Switch S3 on control board for jumping between 0mA~20mA and 0V~10V. Factory default: 0V~10V. Realize motor thermal detection analog input by switch S4.
AI3	模拟量输入3 Analog input 3	-10V~10V: 输入阻抗25kΩ 最大输入电压范围: -12.5V~+12.5V -10V~10V: input impedance 25kΩ Max input voltage range: -12.5V~+12.5V

类别 Category	模拟量输出 Analog output	技术规格 Specification
端子符号 Terminal	端子名称 Terminal designation	技术规格 Specification
AO1	模拟量输出1 Analog output 1	0mA~20mA: 阻抗要求200Ω~500Ω, 0V~10V: 阻抗要求≥10kΩ, 通过跳线开关S5实现0mA~20mA与0V~10V模拟量输出的切换, 出厂默认电压输出。 0mA~20mA: impedance 200Ω~500Ω, 0V~10V: impedance ≥10kΩ. Switch S5 on control board for jump between 0mA~20mA and 0V~10V output. Factory default: 0V~10V.
AO2	模拟量输出2 Analog output 2	0mA~20mA: 阻抗要求200Ω~500Ω, 0V~10V: 阻抗要求≥10kΩ, 通过跳线开关S6实现0mA~20mA与0V~10V模拟量输出的切换, 出厂默认电压输出。 0mA~20mA: impedance 200Ω~500Ω, 0V~10V: impedance ≥10kΩ. Switch S6 on control board for jump between 0mA~20mA and 0V~10V output. Factory default: 0V~10V.
GND	模拟地 Analog ground	内部与COM隔离 Isolated from COM interiorly

类别 Category	端子符号 Terminal	端子名称 Terminal designation	技术规格 Specification
开关量输出 Digital output	Y1	开路集电极输出 Open collector output	电压范围: 0V~24V Voltage range: 0V~24V 电流范围: 0mA~50mA Current range: 0mA~50mA
	Y2/DO	开路集电极输出/脉冲输出 Open collector out / Pulse out	开路集电极输出: 同Y1 Open collector output: same as Y1 脉冲输出: 0kHz~50kHz Pulse output: 0kHz~50kHz
继电器输出1 Relay out 1	RA/RB/RC	继电器输出 Control board relay output	触点容量: 250VAC/3A, 30VDC/3A, Contact capacity: 250VAC/3A, 30VDC/3A.
继电器输出2 Relay out 2	TA/TB/TC	继电器输出 Control board relay output	触点容量: 250VAC/3A, 30VDC/3A, Contact capacity: 250VAC/3A, 30VDC/3A.

类别 Category	开关量输入 Digital input	技术规格 Specification
端子符号 Terminal	端子名称 Terminal designation	技术规格 Specification
+24V	+24V	24V±10%, 内部与GND隔离 最大负载200mA 24V±10%, Isolated from GND interiorly Maximum load 200mA
PLC	开关量输入端子公共端 Digital input common terminal	开关量输入高低电平切换; 出厂时与+24V短接, 开关量输入低有效, 外部电源输入。 Switch between high level and low level. Short-circuited with +24V at delivery, low value of digital input valid. External power input.
COM	+24V地 +24V ground	内部与GND隔离 Isolated from GND interiorly
X1~X6	开关量输入端子1~6 Digital input terminals 1~6	输入规格: 24VDC, 5mA 频率范围: 0Hz~200Hz 电压范围: 10V~30V Input: 24VDC, 5mA Frequency range: 0Hz~200Hz Voltage range: 10V~30V
X7/DI	开关量输入/脉冲输入 Digital input/pulse input	开关量输入: 同X1~X6 脉冲输入: 0.1Hz~50kHz; 电压范围: 10V~30V。 Digital input: same as X1~X6 Pulse input: 0.1Hz~50kHz. Voltage range: 10~30V.

类别 Category	编码器信号输入 Encoder signal input	技术规格 Specification
端子符号 Terminal	端子名称 Terminal designation	技术规格 Specification
VCC	编码器电源 Power supply of encoder	通过S7选择编码器5V/12V电源 Select 5V/12V by switch S7
COM	编码器电源地 Encoder power ground	内部与GND隔离 Isolated from GND interiorly
A+	A相输入正 Input A+	通过S7选择差分/OC输入模式; OC模式时, 该端子不接。 Select differential/OC by switch S7. In OC mode, this terminal is unconnected.
A-	A相输入负 Input A-	通过S7选择差分/OC输入模式; OC模式时, 该端子直接与编码器A相信号相连。 Select differential/OC by switch S7. In OC mode, this terminal is connected with encode A signal.
B+	B相输入正 Input B+	通过S7选择差分/OC输入模式; OC模式时, 该端子不接。 Select differential/OC by switch S7. In OC mode, this terminal is unconnected.
B-	B相输入负 Input B-	通过S7选择差分/OC输入模式; OC模式时, 该端子直接与编码器B相信号相连。 Select differential/OC by switch S7. In OC mode, this terminal is connected with encode B signal.

类别 Category	端子485接口 Terminal 485 Interface	操作面板485接口 Keypad 485 interface	技术规格 Specification
端子符号 Terminal	端子名称 Terminal designation	技术规格 Specification	技术规格 Specification
485+	485差分信号正 Differential signal 485+	速率: 4800/9600/19200/38400/57600/115200bps Rate: 4800/9600/19200/38400/57600/115200bps 最长距离500m(采用标准网线) Maximum distance: 500m (use standard network cable)	
485-	485差分信号负 Differential signal 485-		
GND	485通讯屏蔽接地 485 communication shielded ground	内部与COM隔离 Isolated from COM interiorly	
CN4	操作面板485接口 Keypad 485 interface	连接操作面板时最长通讯距离15m Maximum communication distance is 15m when connected to keypad 采用标准网线 Use standard network cable	

产品特点

Products Features

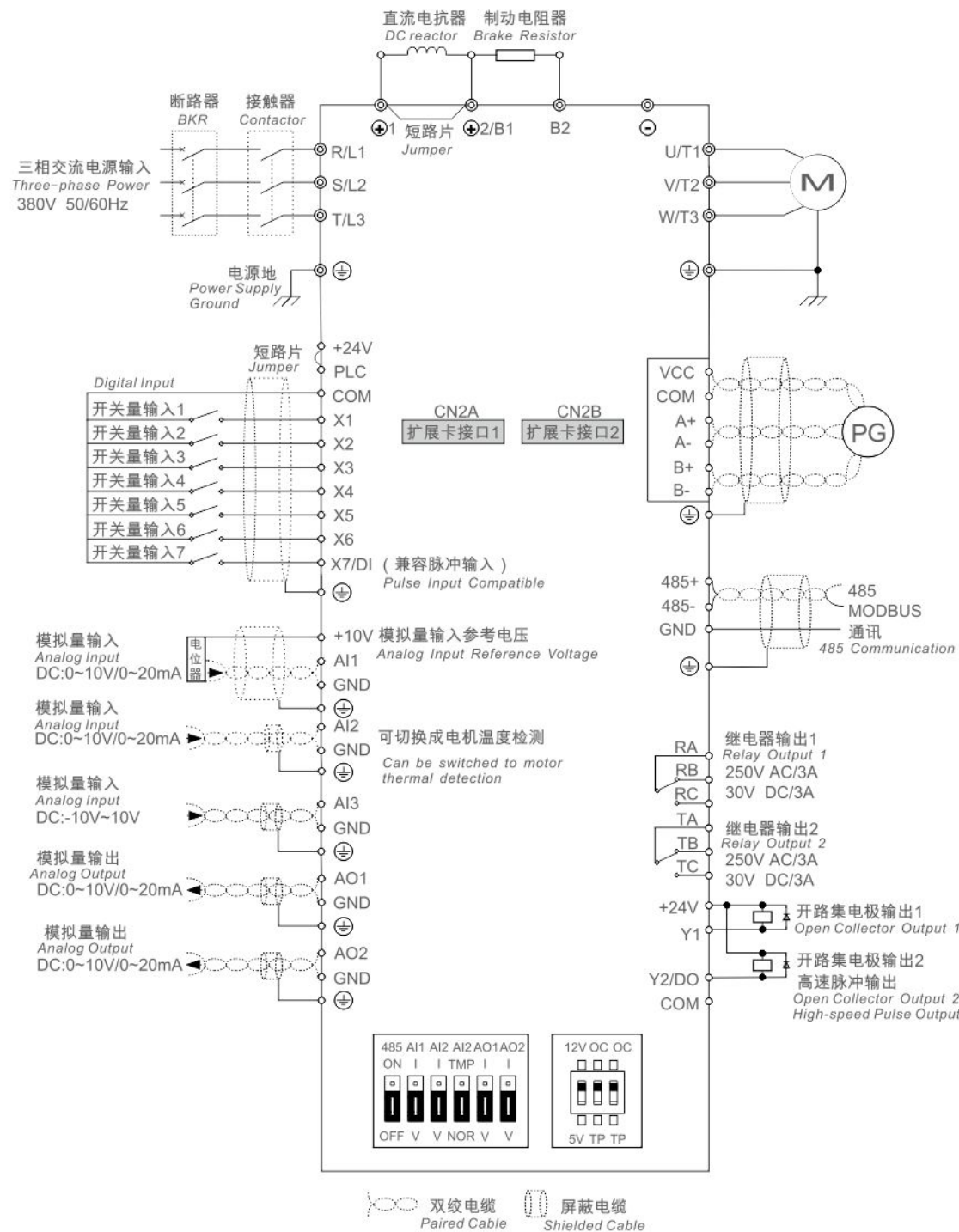

GK600产品型号命名规则

GK600 Model Explanation

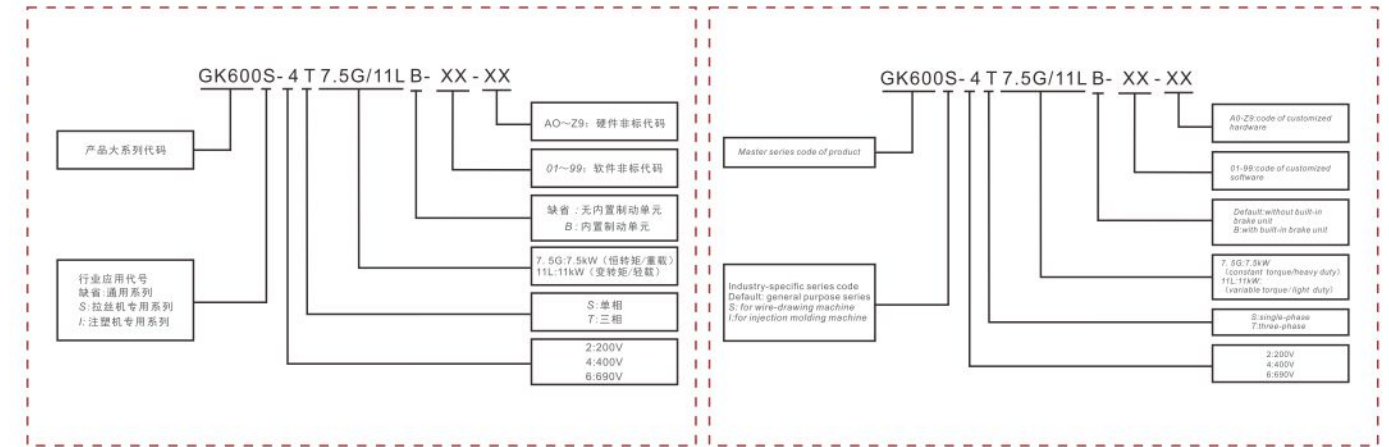

GK600产品型号及技术数据

Model Information of GK600 Series

产品型号 Model	功率(kW) Power	三相输出电流(A) Three-phase output current	单相输入电流(A) Single-phase Input current	三相输入电流(A) Three-phase Input current	适配电机(kW) Applicable motor	制动单元 Brake unit
GK600-2T0.4B	0.4	2.6	5.5	3.2	0.4	标准内置 Inbuilt
GK600-2T0.75B	0.75	4.5	9.2	6.3	0.75	
GK600-2T1.5B	1.5	7.5	14.5	9	1.5	

产品型号 Model	功率等级(kW) Power rating	输出电流(A) Output current	输入电流(A) Input current	适配电机(kW) Applicable motor	制动单元 Brake unit
GK600-4T0.75G/1.5LB	0.75G	2.5	3.5	0.75	标准内置 Inbuilt
	1.5L	1.5	3.8	1.5	
GK600-4T1.5G/2.2LB	1.5G	1.5	3.8	1.5	
	2.2L	2.2	4.8	2.2	
GK600-4T2.2G/3.7LB	2.2G	2.2	5.5	2.2	
	3.7L	3.7	8.0	3.7	
GK600-4T3.7G/5.5LB	3.7G	3.7	9.0	3.7	
	5.5L	5.5	11	5.5	
GK600-4T5.5G/7.5LB	5.5G	5.5	13	5.5	
	7.5L	7.5	16	7.5	
GK600-4T7.5G/11LB	7.5G	7.5	17	7.5	
	11L	11	21	11	
GK600-4T11G/15LB	11G	11	24	11	
	15L	15	30	15	
GK600-4T15G/18.5LB	15G	15	30	15	
	18.5L	18.5	36	18.5	

产品特点

Products Features

产品型号 Model	功率等级(kW) Power rating	输出电流(A) Output current	输入电流(A) Input current	适配电机(kW) Applicable motor	制动单元 Brake unit
GK600-4T18.5G/22L(B)*	18.5G	18.5	39	44	18.5
	22L	22	45	50	22
GK600-4T22G/30L(B)*	22G	22	45	50	22
	30L	30	56	60	30
GK600-4T30G/37L(B)*	30G	30	60	65	30
	37L	37	72	76	37
GK600-4T37G/45L(B)*	37G	37	75	80	37
	45L	45	91	95	45
GK600-4T45G/55L(B)*	45G	45	91	95	45
	55L	55	112	118	55
GK600-4T55G/75L(B)*	55G	55	112	118	55
	75L	75	142	148	75
GK600-4T75G/90L(B)*	75G	75	150	157	75
	90L	90	176	180	90

产品型号 Model	功率等级(kW) Power rating	输出电流(A) Output current	输入电流(A) Input current	适配电机(kW) Applicable motor	制动单元 Brake unit
GK600-4T90G/110L	90G	90	176	180**	90
	110L	110	210	192**	110
GK600-4T110G/132L	110G	110	210	192**	110
	132L	132	250	230**	132
GK600-4T132G/160L	132G	132	253	232**	132
	160L	160	304	280**	160
GK600-4T160G/185L	160G	160	310	285**	160
	185L	185	350	326**	185
GK600-4T185G/200L	185G	185	350	326**	185
	200L	200	380	354**	200
GK600-4T200G/220L	200G	200	380	354**	200
	220L	220	430	403**	220
GK600-4T220G/250L	220G	220	430	403**	220
	250L	250	470	441**	250
GK600-4T250G/280L	250G	250	470	441**	250
	280L	280	520	489**	280
GK600-4T280G/315L	280G	280	520	489**	280
	315L	315	590	571**	315
GK600-4T315G/355L	315G	315	590	571**	315
	355L	355	650	624**	355
GK600-4T355G/400L	355G	355	650	624**	355
	400L	400	725	699**	400
GK600-4T400G/450L	400G	400	725	699**	400
	450L	450	820	790**	450
GK600-4T450G/500L	450G	450	820	790**	450
	500L	500	860	835**	500

产品型号 Model	功率等级(kW) Power rating	输出电流(A) Output current	输入电流(A) Input current	适配电机(kW) Applicable motor	制动单元 Brake unit
GK600-4T500G	500G	500	860	835**	500
GK600-4T560G	560G	560	950	920**	560
GK600-4T630G	630G	630	1100	1050**	630

* 表示该功率等级变频器制动单元可选内置；以18.5/22L为例：不带制动单元型号为GK600-4T18.5G/22L，带制动单元型号为GK600-4T18.5G/22LB，制动电阻需外配
 ** 配置直流电抗器后的输入电流，90kW~500kW 产品出厂配置外置直流电抗器，请务必将电抗器接入使用，否则会导致产品不能正常运行；560kW和630kW 产品为机柜式安装，内置直流电抗器和交流输出电抗器。
 * Means brake unit is optionally inbuilt. Take 18.5G/22L for example: the model without brake unit is GK600-4T18.5G/22L, and the model with brake unit is GK600-4T18.5G/22LB. Brake resistor needs to be mounted externally
 ** Means the rated input current with the configuration of a DC reactor. The drive GK600-4T90G/110L and above are provided with external-mounted DC reactor in shipment as default. Be sure to connect the DC reactors. Failure to comply may result in drive abnormal running.

GK600技术规格

Technical Features of GK600

功率输入 Power input			
额定电压 Rated input voltage	额定输入电流 Rated input current	频率 Frequency	允许电压范围 Allowable voltage range
200V电压等级：单/三相 200V~240V 400V电压等级：三相 380V~480V	参见GK600产品型号及技术数据表	50Hz/60Hz， 波动范围±5%。	电压持续波动±10%，短暂波动-15%~+10%，即：200V电压等级：170V~264V； 400V电压等级：323V~528V。 电压不平衡率<3%，畸变率满足IEC61800-2要求。
For 200V Voltage Rate: single/three phase 200V~240V. For 400V Voltage Rate: three phase 380~480V	See the table "Model information of GK600 series"	50Hz/60Hz, tolerance ±5%.	Voltage consecutive fluctuation ±10%, short fluctuation -15%~10%, i.e. 200V Power rating: 170V~264V; 400V Power rating: 323V~528V. Voltage out-of-balance rate <3%, THD meets standard IEC61800-2.

运行控制特性 Control characteristics

控制方式 Control pattern	V/F控制 V/F control	无PG矢量控制1 Speed-sensorless control 1	无PG矢量控制2 Speed-sensorless control 2
启动转矩 Start torque	0.5Hz 180%	0.5Hz 180%	0.25Hz 180%
调速范围 Speed range	1:100	1:100	1:200
稳速精度 Speed accuracy	±0.5%	±0.2%	±0.2%
速度波动 Speed ripple	-	±0.3%	±0.3%
转矩响应时间 Torque response	-	<10ms	<10ms

功率输出 Power output

标准适用电机 Applicable motor	额定电流 Rated current	输出电压 Output voltage	输出频率 Output frequency	过载能力 Over load capability
参见GK600产品型号及技术数据表	参见GK600产品型号及技术数据表	3相：0~额定输入电压， 误差小于±3%	0.00Hz~600.00Hz， 单位0.01Hz。	150% 1分钟；180% 10秒； 200% 0.5秒。
See the table "Model information of GK600 series"	See the table "Model information of GK600 series"	3-phase: 0~rated input voltage, error less than ±3%	0.00Hz~600Hz, Resolution 0.01Hz.	150% 1min; 180% 10s; 200% 0.5s.

产品特点

Products Features

基本功能 Basic functions	
启动频率 Start frequency	0.00Hz~600.00Hz
加减速时间 Accel/Decel time	0.00s~60000s
载波频率 Carrier frequency	0.7kHz~16kHz
频率设定方式 Frequency command modes	数字设定+操作面板Up/Down; 数字设定+端子Up/Down设定; 上位机通讯设定; 模拟设定; AI1/AI2; 端子脉冲设定。 Digital setting + Keypad Up/Down; Digital setting+terminal Up/Down; Communication setting; Analog setting; AI1/AI2; Terminal pulse setting.
启动方式 Start methods	从启动频率启动; 先直流制动再起; 速度搜索启动。 Start from starting frequency; DC injection braking at start; Flying start.
停机方式 Stop methods	减速停机; 自由停车; 减速停机+直流制动。 Ramp to stop; Coast to stop; DC injection braking at ramp stop.
能耗制动能力 Dynamic brake capability	75kW及以下制动单元可内置 制动单元动作电压: 200V电压等级: 325V~375V;400V电压等级: 650V~750V, 使用时间0.0s~100.0s。 Braking units are optionally inbuilt for drives of 75kw and below. For 200V voltage grade: 325V~375V. For 400V voltage grade: 650V~750V. Service time: 0.0s~100.0s.
直流制动能力 DC braking capability	直流制动起始频率: 0.00Hz~600.00Hz; 直流制动电流: 恒转矩0.0~100%; 直流制动时间: 0.0s~30.00s。 DC braking start frequency: 0.00Hz~600.00Hz; DC braking current: constant torque 0.0~100.0%; DC braking time: 0.0s~30.00s.
输入端子 Input terminals	六个开关量输入端子, 其中一个可作高速脉冲输入, 可支持干节点、有源PNP、NPN输入方式; 两个模拟量输入端子, 其中一个只能用作电压输入, 另一个电压电流可选。 Six digital input terminals, one of them can be used for pulse input, compatible with dry contact, active PNP and NPN input. Two analog input terminals, one of them is voltage only, and the other is voltage/current programmable.
输出端子 Output terminals	一个高速脉冲输出端子(0kHz~50kHz的方波信号输出), 一个模拟量输出端子(电压电流分别可选), 可实现设定频率、输出频率等物理量的输出; 一个开关量输出端子; 一组继电器输出端子。 One high-speed pulse output (0kHz~50kHz square wave signal output), one analog output (voltage/current programmable), can output signals such as command frequency, output frequency, etc. One digital output and one relay output.
保护功能 Protection	参见GK600说明书第七章故障诊断 Refer to "Chapter 7 Troubleshooting" in user manual of GK600 series

特色功能

Characteristic functions

参数拷贝、参数备份、共直流母线、两组电机参数自由切换、灵活的功能码显隐性、各种主辅给定以及切换、速度搜索、多种加减速曲线选择、模拟量自动校正、抱闸控制、最多可支持16段速运行（两段速支持灵活的频率给定方式）、摆频控制运行、定长控制、计数功能、三组故障记录、过励磁制动、过压失速、欠压失速、掉电再启动、跳跃频率、频率绑定、四段加减速时间自由切换、电机温度保护、灵活的风扇控制、过程PID控制、简易PLC, 灵活的多功能键设置、下垂控制、参数辨识、弱磁控制、高精度的转矩限定、V/F分离控制。

Parameter copy, parameter backup, common DC bus, two motors profiles programmable, flexible parameter display & hiding, various master & auxiliary command and switchover, reliable speed search started, a variety of Accel/Decel curves programmable, autocorrection of analog, contracting brake control, 16-step speed control programmable (2 steps support flexible frequency command), wobble frequency control, fixed length control, count function, three faults history, over excitation brake, overvoltage stall protection programmable, undervoltage stall protection programmable, restart upon power loss, skip frequency, frequency binding, four kinds of Accel/Decel time, motor thermal protection, flexible fan control, process PID control, simple PLC, multi-functional key programmable, droop control, asynchronous and synchronous motor parameters autotune, field weakening control, high-precision torque control, V/F separated control.

环境 Environment					
使用场所 Field	海拔高度 Altitude	环境温度 Temperature	湿度 Humidity	振动 Vibration	存储温度 Storage temperature
室内, 不受阳光直射, 无尘埃、腐蚀性气体、油雾、水蒸气、滴水或盐分等。 Indoors, no direct sunlight, free from dust, corrosive gases, flammable gases, oil mist, water vapor, water drop, salt, etc.	0m~2000m: 1000m以上降额使用, 每升高100m, 额定输出电流减少1%。 0m~2000m: de-rate 1% for every 100m when above 1000 meters.	-10°C~+40°C, 40°C~50°C之间降额使用, 每升高1°C, 额定输出电流减少1%。 -10°C~+40°C, 40°C~50°C: rated output current de-rates 1% for every 1°C.	5%~95%, 不允许凝露。 5%~95%, no condensation.	小于5.9m/s ² (0.6g) Less than 5.9m/s ² (0.6g)	-40°C~+70°C
其它 Others					
效率 Efficiency	安装方式 Installation	防护等级 Protection grade	冷却方式 Cooling method		
额定功率时, 7.5kW及以下功率等级: ≥93%; 11kW~45kW功率等级: ≥95%; 55kW以上功率等级: ≥98%。 At rated Amps, 7.5kW and below: ≥93%. 11kW~45kW: ≥95%; 55kW and above: ≥98%.	壁挂式(500kW及以下) 柜式(560kW和630kW) Wall-mounted type(500kW and below) Cabinet type(560kW and 630kW)	IP20	强迫风冷 Forced air cooling		

GK600产品外形和安装尺寸

External Dimensions of GK600

产品型号 Model	外形和安装尺寸(mm) External dimensions							重量(kg) Weight
	W	H	D	W1	H1	H2	安装孔直径 Mounting hole dia.	
GK600-2T0.4B	93	190	152	70	180	172	4.5	1.4
GK600-2T0.75B								
GK600-2T1.5B								
GK600-4T0.75G/1.5LB	93	190	152	70	180	172	4.5	1.4
GK600-4T1.5G/2.2LB								
GK600-4T2.2G/3.7LB								
GK600-4T3.7G/5.5LB	120	245	169	80	233	220	5.5	2.9
GK600-4T5.5G/7.5LB								
GK600-4T7.5G/11LB								
GK600-4T11G/15LB	145	280	179	105	268	255	5.5	3.9
GK600-4T15G/18.5LB								
GK600-4T18.5G/22L(B)								
GK600-4T22G/30L(B)	270	475	220	170	460	435	8	15.5
GK600-4T30G/37LB(B)								
GK600-4T37G/45LB(B)								
GK600-4T45G/55LB(B)	320	568	239	220	544	515	10	24
GK600-4T55G/75L(B)								
GK600-4T75G/90L(B)								
GK600-4T90G/110L	385	670	261	260	640	600	12	37
GK600-4T110G/132L								
GK600-4T132G/160L								
GK600-4T160G/185L	395	785	291	260	750	705	12	50
GK600-4T185L								
	440	900	356	300	865	820	14	66

产品特点

Products Features

产品型号 Model	外形和安装尺寸(mm) External dimensions							重量(kg) Weight
	W	H	D	W1	H1	H2	安装孔直径 Mounting hole dia.	
GK600-4T185G/200L	500	990	368	360	950	900	14	88
GK600-4T200G/220L								
GK600-4T220G/250L								
GK600-4T250G/280L	650	1040	406	400	1000	950	14	123
GK600-4T280G/315L								
GK600-4T315G/355L								
GK600-4T355G/400L	815	1300	428	600	1252	1200	14	165
GK600-4T400G/450L								
GK600-4T450G/500L								
GK600-4T500G								
GK600-4T560G								
GK600-4T630G	1100	2000	550	/	/	/	/	515

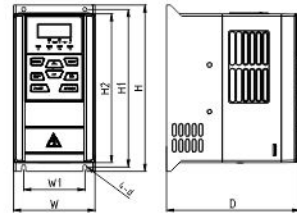

a) GK600-2T0.4B~GK600-2T1.5B
& GK600-4T0.75G/1.5LB~GK600-4T1.5G/2.2LB



b) GK600-4T2.2G/3.7LB~GK600-4T15G/18.5LB

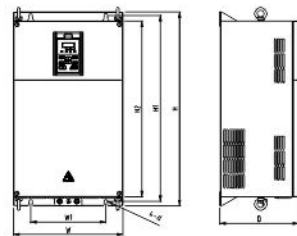

c) GK600-4T18.5G/22L(B)~GK600-4T75G/90L(B)

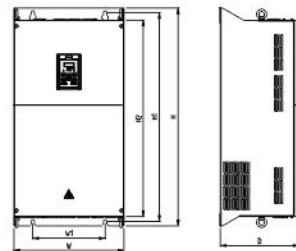

d) GK600-4T90G/110L~GK600-4T160G/185L

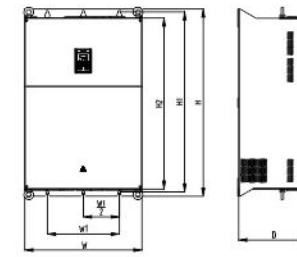

e) GK600-4T185G/200L~GK600-4T500G

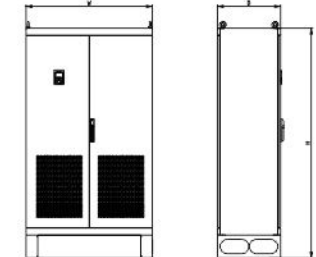

f) GK600-4T560G~GK600-4T630G

GK600控制端子功能说明

Specification of GK600 Control Terminals

类别 Category	模拟量输入 Analog input	技术规格 Specification
端子符号 Terminal	端子名称 Terminal designation	
+10 V	模拟量输入参考电压 Analog input reference voltage	电压: 10.3V±3%, 最大输出电流25mA, 即外接电位器时需选大于400Ω的电位器。 Voltage: 10.3V±3%, Maximum output current: 25mA. Resistance of external potentiometer should be larger than 400Ω.
GND	模拟地 Analog ground	内部与COM隔离 Isolated from COM interiorly
AI1	模拟量输入1 Analog input 1	0mA~20mA: 输入阻抗500Ω, 最大输入电流25mA; 0V~10V: 输入阻抗22kΩ, 最大输入电压12.5V; 通过跳线开关S2实现0mA~20mA与0V~10V模拟量输入的切换, 出厂默认电压输入。 0mA~20mA: input impedance 500Ω, maximum input current 25mA. 0V~10V: input impedance 22kΩ, maximum input voltage 12.5V. 0mA~20mA/0V~10V programmable by switch S2. Factory default: 0V~10V.
AI2	模拟量输入2 Analog input 2	-10V~10V: 输入阻抗25kΩ 最大输入电压范围: -12.5V~+12.5V -10V~10V: input impedance 25kΩ Max input voltage range: -12.5V~+ 12.5V

类别 Category	模拟量输出 Analog output	技术规格 Specification
端子符号 Terminal	端子名称 Terminal designation	
AO1	模拟量输出1 Analog output 1	0mA~20mA: 阻抗要求200Ω~500Ω; 0V~10V: 阻抗要求≥10kΩ; 通过跳线开关S3实现0mA~20mA与0V~10V模拟量输出的切换, 出厂默认电压输出。 0mA~20mA: impedance 200Ω~500Ω. 0V~10V: impedance ≥10kΩ. Switch S3 on control board for jump between 0mA~20mA and 0V~10V output ;Factory default: 0V~10V.
GND	模拟地 Analog ground	内部与COM隔离 Isolated from COM interiorly

产品特点

Products Features

类别 Category	开关量输出 Analog output	技术规格 Specification	
端子符号 Terminal	端子名称 Terminal designation		
Y1	开路集电极输出 Open collector output	电压范围: 0V~24V Voltage range: 0V~24V	电流范围: 0mA~50mA Current range: 0mA~50mA
Y2/DO	开路集电极输出/脉冲输出 Open collector out / Pulse out	开路集电极输出: 同Y1 Open collector output: same as Y1	脉冲输出: 0kHz~50kHz Pulse output: 0kHz~50kHz

类别 Category	开关量输入 Analog input	技术规格 Specification	
端子符号 Terminal	端子名称 Terminal designation		
+24V	+24V	24V±10%，内部与GND隔离； 最大负载200mA。 24V±10%，Isolated from GND interiorly. Maximum load 200mA.	
PLC	开关量输入端子公共端 Digital input common terminal	开关量输入高低电平切换，出厂时与+24V短接，开关量输入低有效，外部电源输入。 Used for switching between high and low levels. Short-circuited with +24V at delivery, i.e. low value of digital input valid. External power input.	
COM	+24V地 +24V ground	内部与GND隔离 Isolated from GND interiorly	
X1~X5	开关量输入端子1~5 Digital input terminals 1~5	输入规格: 24VDC, 5mA; 频率范围: 0Hz~200Hz; 电压范围: 10V~30V。 Input: 24VDC, 5mA. Frequency range: 0Hz~200Hz. Voltage range: 10V~30V.	
X6/DI	开关量输入/脉冲输入 Digital input/pulse input	开关量输入: 同X1~X5; 脉冲输入: 0.1Hz~50kHz; 电压范围: 10V~30V。 Digital input: same as X1~X5. Pulse input: 0.1Hz~50kHz; Voltage range: 10V~30V.	

类别 Category	端子485接口 Terminal 485 Interface	技术规格 Specification	
端子符号 Terminal	端子名称 Terminal designation		
485+	485差分信号正 Differential signal 485+	速率: 4800/9600/19200/38400/57600/115200bps Rate: 4800/9600/19200/38400/57600/115200bps 最长距离500m(采用标准网线) Maximum distance: 500m (use standard network cable)	
485-	485差分信号负 Differential signal 485-		
GND	485通讯屏蔽接地 485 communication shielded ground	内部与COM隔离 Isolated from COM interiorly	

类别 Category	继电器输出 Relay output	操作面板485接口 Keypad 485 interface	技术规格 Specification	
端子符号 Terminal	端子名称 Terminal designation			
RA/RB/RC	继电器输出 Control board relay output	RA-RB: 常闭; RA-RC: 常开。 RA-RB: NC; RA-RC: NO.	触点容量: 250VAC/3A, 30VDC/3A。 Contact capacity: 250VAC/3A, 30VDC/3A.	
CN4(CN12)	操作面板485接口 Keypad 485 interface	连接操作面板时最长通讯距离15m Maximum communication distance is 15m when connecting to keypad	采用标准网线 Use standard network cable	

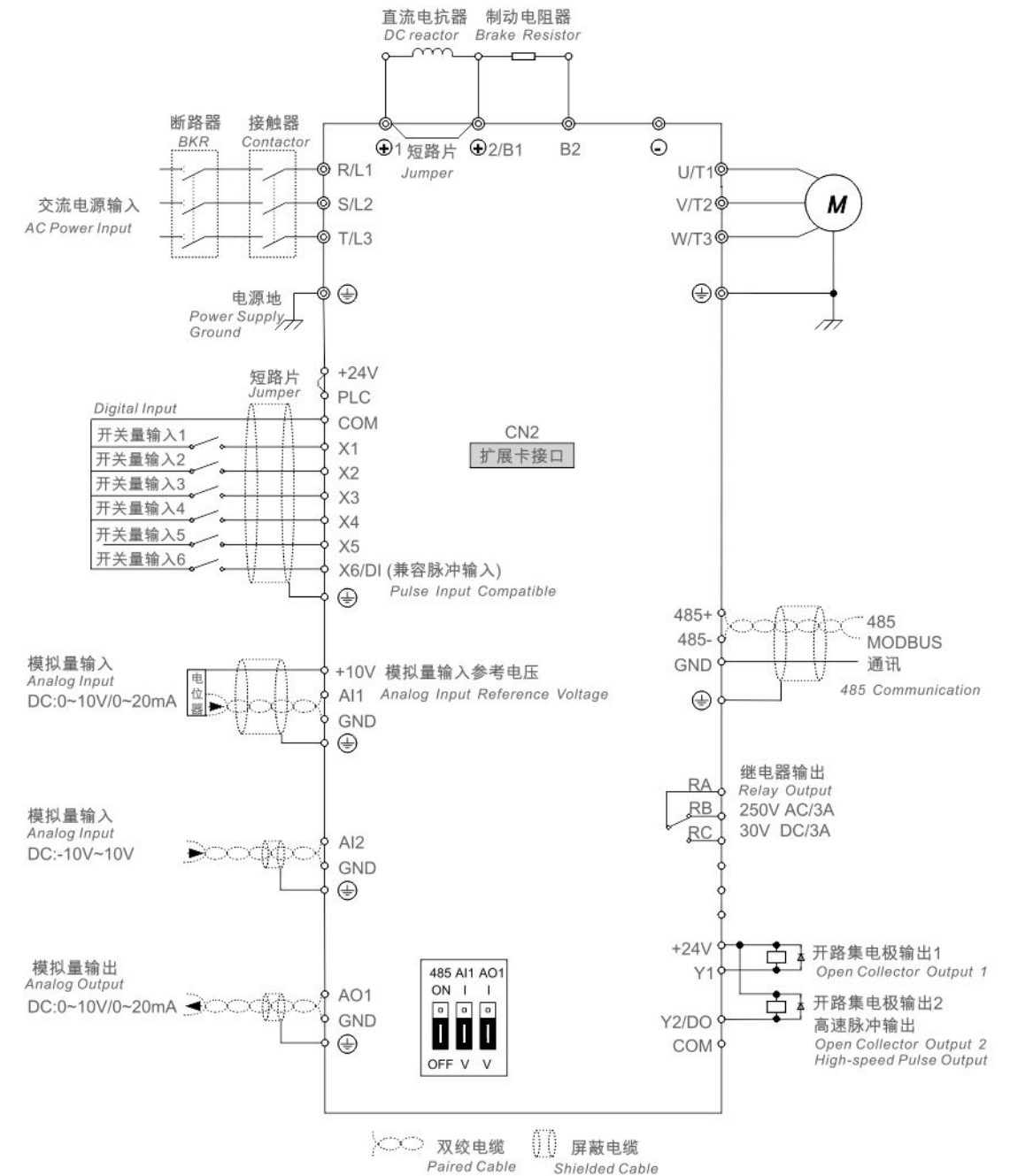

产品特点

Products Features

GK500产品型号命名规则 GK500 Model Explanation

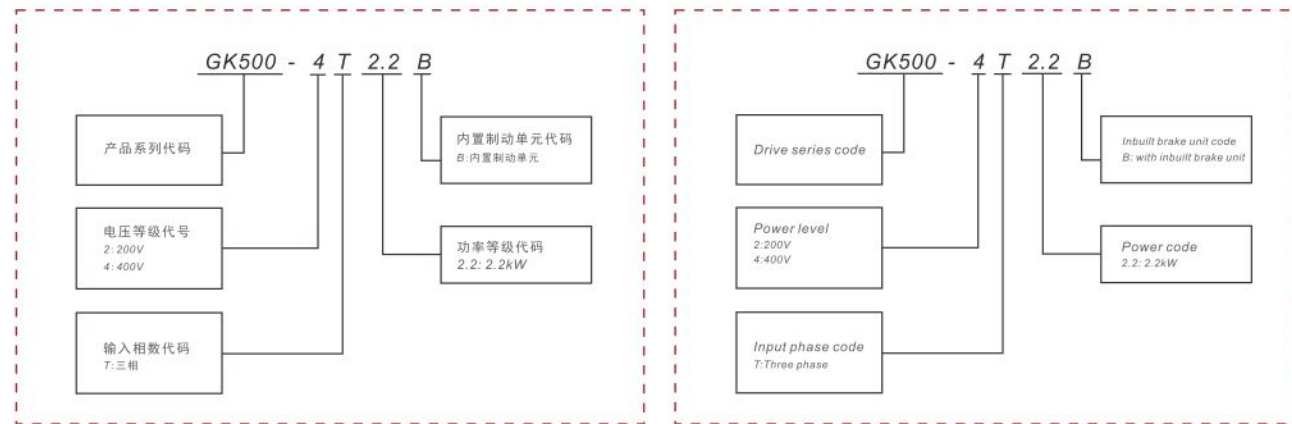

GK500产品型号及技术数据 Model Information of GK500 Series

电压等级 Voltage	产品型号 Model	功率等级 (kW) Power rating	输出电流 (A) Output current	三相输入电流 (A) Three-phase Input current	单相输入电流 (A) Single-phase Input current	适配电机 (kW) Applicable motor	制动单元 Brake unit
200V*	GK500-2T0.4B	0.4	2.6	3.2	5.5	0.4	标准内置 Inbuilt
	GK500-2T0.75B	0.75	4.5	6.3	9.2	0.75	
	GK500-2T1.5B	1.5	7.5	9	14.5	1.5	
	GK500-2T2.2B	2.2	11	15	23	2.2	
400V	GK500-4T0.75B	0.75	2.5	3.5	/	0.75	
	GK500-4T1.5B	1.5	3.8	5.0	/	1.5	
	GK500-4T2.2B	2.2	5.5	6.0	/	2.2	
	GK500-4T3.7B	3.7	9	10.5	/	3.7	

*200V等级机型兼容单相和三相电源输入

* 200V level compatible to single phase and three phase power input

GK500技术规格 Technical Features of GK500

功率输入 Power input			
额定电压 Rated input voltage	额定输入电流 Rated input current	频率 Frequency	允许电压范围 Allowable voltage range
3相380VAC~480VAC; 3相200VAC~240VAC; 单相200VAC~240VAC.	参见GK500产品型号及技术数据表	50Hz/60Hz, 波动范围±5%.	电压持续波动±10%, 短暂波动-15%~+10%, 电压失平衡率<3%, 畸变率满足IEC61800-2要求。
3-phase 380VAC~480VAC; 3-phase 200VAC~240VAC; single phase 200VAC~240VAC.	See the table "Model information of GK500 series"	50Hz/60Hz, tolerance ±5%.	Voltage consecutive fluctuation ±10%, short fluctuation -15%~+10%. Voltage out-of-balance rate <3%, THD meets standard IEC61800-2.

功率输出 Power output

标准适用电机 (kW) Applicable motor	额定电流 Rated current	输出电压 Output voltage	输出频率 Output frequency	过载能力 Over load capability
参见GK500产品型号及技术数据表 See the table "Model information of GK500 series"	参见GK500产品型号及技术数据表 See the table "Model information of GK500 series"	3相: 0~额定输入电压, 误差小于±3% 3-phase: 0~rated input voltage, error less than ±3%	0.00Hz~600Hz, 单位0.01Hz 0.00Hz~600Hz, Resolution 0.01Hz	150% 1分钟; 180% 10秒; 200% 0.5秒, 间隔10分钟 150% 1min, 180% 10s, 200% 0.5s, once per 10 mins

运行控制特性 Control characteristics

控制方式 Control pattern	启动转矩 Start torque	调速范围 Speed range	稳速精度 Speed accuracy	速度波动 Speed ripple	转矩响应时间 Torque response	启动频率 Start frequency	加减速时间 Accel/Decel time	载波频率 Carrier frequency
V/f控制 V/f control	0.5Hz 180%	1:100	±0.5%	—	—	0.00Hz~600.00Hz	0.00s~60000s	0.7kHz~16kHz

基本功能 Basic functions

频率设定方式 Frequency command modes	启动方式 Start methods	停机方式 Stop methods	能耗制动能力 Dynamic brake capability	直流制动能力 DC braking capability	输入端子 Input terminals	输出端子 Output terminals
数字设定+操作面板 Up/Down; 数字设定+端子Up/Down设定; 上位机通讯设定; 面板电位器模拟量输入; 端子模拟量输入。	从启动频率启动; 先直流制动再启动; 速度搜索启动。	减速停机; 自由停车; 减速停机+直流制动。	电压等级400V: 制动单元动作电压: 650V~750V; 使用时间0.0s~100.0s。 电压等级200V: 制动单元动作电压: 325V~375V; 使用时间0.0s~100.0s。	直流制动起始频率: 0.00Hz~600.00Hz; 直流制动电流: 恒转矩0.0~100%; 直流制动时间 0.0s~30.00s。	四个开关量输入端子; 一个模拟量输入端子, 电压/电流可选。	一个开关量输出端子, 一组继电器输出端子, 一个模拟量输出端子(电压/电流分别可选), 可实现设定频率、输出频率等物理量的输出。
Digital setting + Keypad Up/Down. Digital setting+ terminal Up/Down. Communication setting; Keypad POT analog input. Terminals analog input.	Start from starting frequency. DC injection braking at start. Flying start.	Ramp to stop. Coast to stop. DC injection braking at ramp stop.	For rated voltage 400V, the braking unit triggered voltage: 650V~750V. Service time: 0.0s~100.0s. For rated voltage 200V, the braking unit triggered voltage: 325V~375V. Service time: 0.0s~100.0s.	DC braking start frequency: 0.00Hz~600.00Hz. DC braking current: constant torque 0.0~100.0%; DC braking time: 0.0s~30.00s.	Four digital inputs. One analog input, voltage/current programmable.	One digital output, one relay output, and one analog output (voltage/current programmable), can output signals such as command frequency, output frequency, etc.

保护功能 Protection

参见GK500说明书第六章故障诊断
Refer to "Chapter 7 Troubleshooting" in user manual of GK500 series

特色功能 Characteristic functions

各种主辅给定以及切换、可靠的速度搜索、多种加减速曲线选择、模拟量自动校正、最多可支持8段速运行（两段速支持灵活的频率给定方式）、三组故障记录、过励磁制动、过压失速、欠电压调节、掉电再启动、频率跳跃、频率绑定、四段加减速时间自由切换、过程PID控制、异步机的参数辨识、弱磁控制、高精度的转矩限定。
Various master & auxiliary command and switchover, flying start, a variety of Accel/Decel curves programmable, autocorrection of analog, 8-step speed control programmable (2 steps support flexible frequency command), three faults history, over excitation brake, over voltage stall protection programmable, under voltage stall protection programmable, restart upon power loss, skip frequency, frequency binding, four kinds of Accel/Decel time, process PID control, asynchronous motor parameters autotune, field weakening control, precise torque control.

产品特点

Products Features

环境 Environment					
使用场所 Field	海拔高度 Altitude	环境温度 Temperature	湿度 Humidity	振动 Vibration	存储温度 Storage temperature
室内，不受阳光直射，无尘埃、腐蚀性气体、油雾、水蒸气、滴水或盐分等。 <i>Indoors, no direct sunlight, free from dust, corrosive gases, flammable gases, oil mist, water vapor, water drop, salt, etc.</i>	0m~2000m: 1000m以上降额使用，每升高100m，额定输出电流减少1%。 <i>0m~2000m: de-rate 1% for every 100m when above 1000 meters.</i>	-10℃~+40℃，40℃~50℃之间降额使用，每升高1℃，额定输出电流减少1%。 <i>-10℃~+40℃, 40℃~50℃: rated output current de-rates 1% for every 1℃.</i>	5%~95%，不允许凝露。 <i>5%~95%, no condensation</i>	小于5.9m/s ² (0.6g) <i>Less than 5.9m/s² (0.6g)</i>	-40℃~+70℃

其它 Others		
安装方式 Installation	防护等级 Protection grade	冷却方式 Cooling method
壁挂式 <i>Wall-mounted</i>	IP20	强迫风冷 <i>Forced air cooling</i>

GK500产品外形和安装尺寸 External Dimensions of GK500

电压等级 Voltage	产品型号 Model	外形和安装尺寸(mm) External dimensions					
		W	H	D	W1	H1	安装孔直径 Mounting hole dia.
200V	GK500-2T0.4B	75	166	168	59	154	4.5
	GK500-2T0.75B						
	GK500-2T1.5B						
	GK500-2T2.2B						
400V	GK500-4T0.75B	75	166	168	59	154	4.5
	GK500-4T1.5B						
	GK500-4T2.2B						
	GK500-4T3.7B						

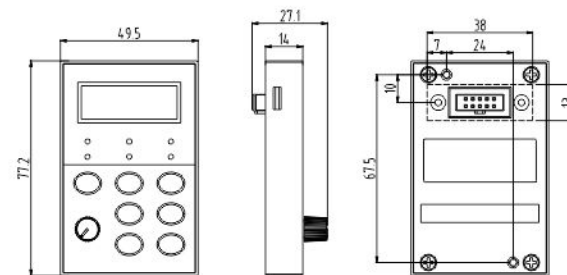

a) 操作面板尺寸
Keypad dimensions

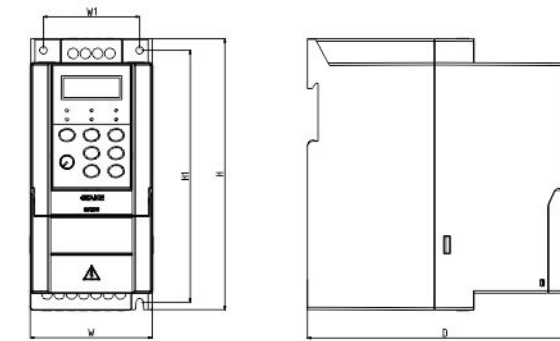

b) GK500机器外形及尺寸
External dimensions of GK500

GK500控制端子功能说明 Specification of GK500 Control Terminals

类别 Category	模拟量输入 Analog input	技术规格 Specification
+10V	模拟量输入参考电压 Analog input reference voltage	最大输出电流25mA 10.3V±3% 即外接电位器时需选大于400Ω的电位器 Voltage: 10.3V±3% Maximum output current: 25mA; Resistance of external potentiometer should be larger than 400Ω
GND	模拟地 Analog ground	内部与COM连接 Connected with COM interiorly
AI	模拟量输入 Analog input	0mA~20mA: 输入阻抗500Ω, 最大输入电流25mA。 0V~10V: 输入阻抗100kΩ, 最大输入电压12.5V。 通过跳线开关AI实现0mA~20mA与0V~10V模拟量输入的切换，出厂默认电压输入。 0mA~20mA: input impedance 500Ω, maximum input current 25mA. 0V~10V: input impedance 100kΩ, maximum input voltage 12.5V. 0mA~20mA/0V~10V programmable by switch AI. Factory default: 0~10V.

类别 Category	模拟量输出 Analog output	技术规格 Specification
AO	模拟量输出 Analog output	0mA~20mA: 阻抗要求200Ω~500Ω 0V~10V: 阻抗要求≥10kΩ 通过跳线开关AO实现0mA~20mA与0V~10V模拟量输出的切换，出厂默认电压输出。 0mA~20mA: impedance 200Ω~500Ω 0V~10V: impedance ≥10kΩ Switch AO on control board for jump between 0mA~20mA and 0V~10V output; Factory default: 0V~10V.
GND	模拟地 Analog ground	内部与COM连接 Connected with COM interiorly

产品特点

Products Features

类别 Category	开关量输入 Digital input	技术规格 Specification
端子符号 Terminal	端子名称 Terminal designation	
+24V	+24V	24V±10%，内部与GND连接， 最大负载100mA。 24V±10%, connected with GND interiorly, Maximum load 200mA.
COM	+24V地 +24V ground	内部与GND连接 Connected with GND interiorly
X1~X4	开关量输入端子1~4 Digital input terminals 1~4	输入规格: 24VDC, 5mA; 频率范围: 0Hz~200Hz; 电压范围: 22V~26V。 Input: 24VDC, 5mA. Frequency range: 0Hz~200Hz. Voltage range: 10V~30V.

类别 Category	开关量输出 Digital output	技术规格 Specification
端子符号 Terminal	端子名称 Terminal designation	
Y	开路集电极输出 Open collector output	电压范围: 0V~24V 电流范围: 0mA~50mA Voltage range: 0V~24V Current range: 0mA~50mA

类别 Category	继电器输出 Relay output	技术规格 Specification
端子符号 Terminal	端子名称 Terminal designation	
RA/RB/RC	继电器输出 Control board relay output	RA-RB: 常闭; RA-RC: 常开。 RA-RB: NC; RA-RC: NO. 触点容量: 250VAC/3A, 30VDC/3A。 Contact capacity: 250VAC/3A, 30VDC/3A.

类别 Category	端子485接口 Terminal 485 Interface	技术规格 Specification
端子符号 Terminal	端子名称 Terminal designation	
485+	485差分信号正 Differential signal 485+	速率: 4800/9600/19200/38400/57600/115200bps Rate: 4800/9600/19200/38400/57600/115200bps
485-	485差分信号负 Differential signal 485-	最长距离500m(采用标准网线) Maximum distance: 500m (use standard network cable)
GND	485通讯屏蔽接地 485 communication shielded ground	内部与COM连接 Connected with COM interiorly

类别 Category	操作面板接口 Keypad interface	技术规格 Specification
端子符号 Terminal	端子名称 Terminal designation	
CN4	操作面板接口 Keypad interface	连接操作面板时最长通讯距离5m Maximum communication distance is 15m when connected to keypad

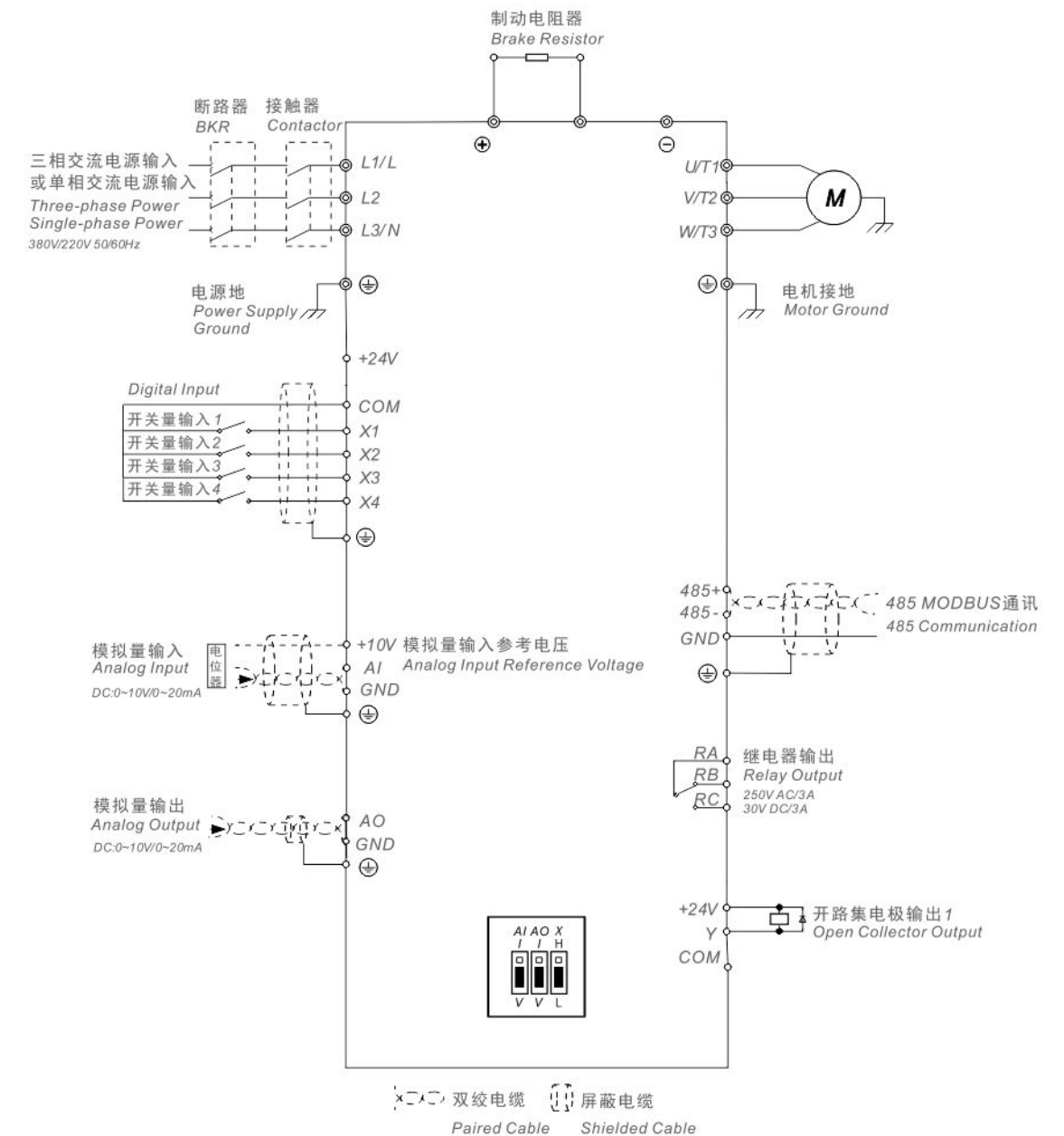

产品特点

Products Features

产品外围器件使用说明

Peripheral Devices

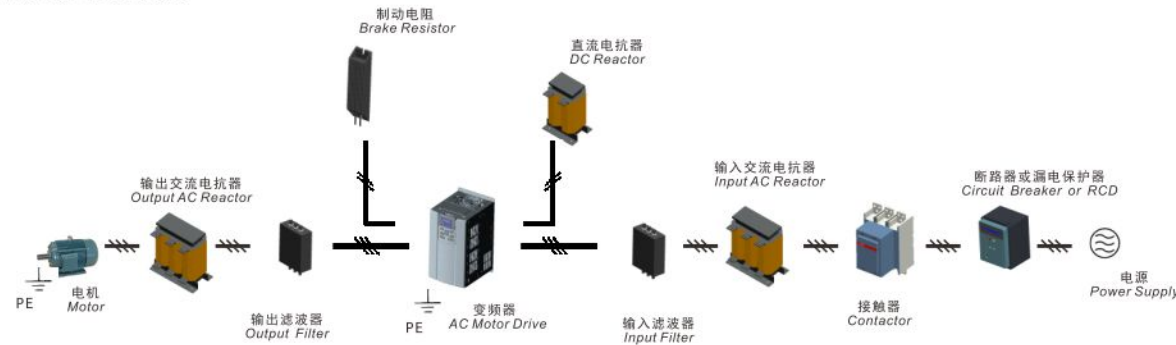

产品外围器件的标准配置图
Standard configuration of peripheral devices

名称 Device	使用说明 Instructions
电源 Power supply	输入三相交流电源需满足说明书规定范围 Triphase AC power supply should be in the range specified in user manuals
断路器 Circuit breaker	用途：在后级设备出现异常过流时，起到分断电源，保护后级的作用。 选型：断路器的分断电流按变频器额定电流的1.5~2倍选取； 断路器的时间特性需根据变频器过载保护的时间特性选取。 Purpose: disconnect power supply and protect the equipments when overcurrent occurs. Type selection: brake current of circuit breaker should be 1.5~2 times the rated current of the drive; brake time characteristic of circuit breaker should be selected based on overload protection time characteristic of the drive.
漏电保护器 RCD	用途：由于变频器的输出是PWM高频斩波电压，因此高频漏电流不可避免。 选型：建议选B型专用漏电保护器。 Purpose: since the drive outputs PWM HF chopping voltage, HF leakage current is inevitable. Type selection: type B dedicated RCD is recommended.
接触器 Contactor	为了确保安全，请不要频繁的闭合和断开接触器，这将引起变频器故障； 不要用闭合和断开接触器对系统通断电的方式控制变频器的启停，这将降低变频器的寿命。 For safety's sake, do not frequently close and break the contactor as this may bring about equipment faults since this will result in a reduction on the product life. Do not control the start & stop of the drive directly through switching on and off the contactor
输入交流电抗器 Input AC reactor	改善功率因数;改善三相输入交流电源不平衡对系统的影响;控制高次谐波，减少对外传导和辐射干扰，有效减少脉冲电流对整流桥的影响。 Improve power factor; Reduce the impact of imbalanced three-phase input AC power supply on the system. Suppress higher harmonics and reduce EMI to peripheral devices; Reduce the impact of impulse current on rectifier bridges.
输入滤波器 Input filter	减少电源端到变频器的传导干扰，提高变频器抗干扰能力，减少变频器对外传导和辐射干扰。 Reduce conducted interference at power supply end, improve the immunity of the drive against noise Reduce conducted and radiated interference of the drive to peripheral devices.
制动单元和制动电阻 Brake unit and braking resistor	用途：制动时，有效地消耗电机回馈的能量而实现快速制动。 选型：制动单元的选型请直接与我司技术人员联系，制动电阻的选型参考外围器件选型表。 Purpose: consume motor feedback energy to attain quick brake. Type selection: contact GTAKE technicians for type selection of brake units. Refer to table "Selection of Peripheral Devices" for type selection of brake resistors.

名称 Device	使用说明 Instructions
输出滤波器 Output filter	减少变频器对外的传导和辐射干扰 Reduce drive EMI to peripheral devices
输出交流电抗器 Output AC reactor	有效避免因谐波电压而损坏电机绝缘；减少因漏电流使得变频器频繁保护。 当变频器到电机的连线超过100m时，建议安装输出交流电抗器。 Avoid motor insulation damage resulted from harmonic voltage. Reduce frequent protection caused by leakage current In case the cable connecting drive and motor is over 100 meters, an output AC reactor is recommended.
电机 Motor	选用与变频器匹配的电机 Should match the drive

外围器件选型表

Selection of Peripheral Devices

产品型号 Model	单相输入 Single-phase input		三相输入 Three-phase input		制动电阻 Brake resistor	
	断路器(A) Circuit breaker	接触器(A) Contactor	断路器(A) Circuit breaker	接触器(A) Contactor	功率(W) Power	电阻(Ω) Resistance
GK600-2T0.4B	10	9	10	9	100	≥50
GK600-2T0.75B	16	12	10	9	150	≥50
GK600-2T1.5B	20	18	16	12	150	≥40

产品型号 Model	断路器 (A) Circuit breaker	接触器 (A) Contactor	制动电阻/制动单元* Brake resistor/brake unit	
			功率(W) Power	电阻(Ω) Resistance
GK600-4T0.75G/1.5LB	10	9	150	≥100
				≥100
GK600-4T1.5G/2.2LB	10	9	150	≥100
				≥100
GK600-4T2.2G/3.7LB	10	9	300	≥100
				≥100
GK600-4T3.7G/5.5LB	16	12	450	≥75
				≥75
GK600-4T5.5G/7.5LB	20	18	500	≥75
				≥75
GK600-4T7.5G/11LB	32	25	500	≥75
				≥75
GK600-4T11G/15LB	40	32	800	≥30
				≥30
GK600-4T15G/22LB	50	40	800	≥30
				≥30

产品特点

Products Features

产品型号 Model	断路器 (A) Circuit breaker	接触器 (A) Contactor	制动电阻/制动单元* Brake resistor/brake unit	
			功率 (W) Power	电阻 (Ω) Resistance
GK600-4T15G/18.5LB	15G	50	1000	≥25
	18.5L	63		
GK600-4T18.5G/22L(B)	18.5G	63	1300	≥16
	22L	63		
GK600-4T22G/30L(B)	22G	63	1500	≥16
	30L	100		
GK600-4T30G/37L(B)	30G	100	2000	≥16
	37L	100		
GK600-4T37G/45L(B)	37G	100	2500	≥10
	45L	125		
GK600-4T45G/55L(B)	45G	125	3000	≥10
	55L	160		
GK600-4T55G/75L(B)	55G	160	3600	≥8
	75L	225		
GK600-4T75G/90L(B)	75G	225	5000	≥5
	90L	250		

产品型号 Model	断路器 (A) Circuit breaker	接触器 (A) Contactor	制动电阻/制动单元* Brake resistor/brake unit	
			功率 (W) Power	电阻 (Ω) Resistance
GK600-4T90G/110L	90G	250	选配制动单元 External brake unit optional	
	110L	315		
GK600-4T110G/132L	110G	315		
	132L	350		
GK600-4T132G/160L	132G	350		
	160L	400		
GK600-4T160G/185L	160G	400		
	185L	500		
GK600-4T185G/200L	185G	500		
	200L	500		
GK600-4T200G/220L	200G	500		
	220L	630		
GK600-4T220G/250L	220G	630		
	250L	630		
GK600-4T250G/280L	250G	630		
	280L	800		

产品型号 Model	断路器 (A) Circuit breaker	接触器 (A) Contactor	制动电阻/制动单元* Brake resistor/brake unit	
			功率 (W) Power	电阻 (Ω) Resistance
GK600-4T280G/315L	280G	800	选配制动单元 External brake unit optional	
	315L	800		
GK600-4T315G/355L	315G	800		
	355L	1000		
GK600-4T355G/400L	355G	1000		
	400L	1250		
GK600-4T400G/450L	400G	1250		
	450L	1250		
GK600-4T450G/500L	450G	1250		
	500L	1600		
GK600-4T500G		1600		
GK600-4T560G		1600		
GK600-4T630G		2000		

GK800同GK600G型机

* 内置制动单元时，制动电阻功率和阻值需满足表中要求；外配制动单元时，制动电阻功率和阻值依据所选制动单元来配置。在满足制动要求的前提下，制动电阻应大于表中规定的最小值，否则有产品损坏的危险！制动电阻都不内置，需要另外采购。

GK800: same as GK600G Drives

* When brake unit is inbuilt, the power and resistance of brake resistor should meet the requirement stated in the table. When brake unit is mounted externally, the power and resistance of brake resistor should be in accordance with brake unit. On the premise of fulfilling brake requirement, brake resistance value might be bigger than the minimum value stated in the table. Failure to comply may result in product damage. Brake resistors are not inbuilt and need to be sourced additionally.



产品特点

Products Features

新能源汽车电机控制器

New Energy Vehicle Motor Controllers

特点

- > 支持交流异步电机和永磁同步电机驱动。
- > 水冷和风冷两种冷却方式可选。
- > 支持旋转变压器和光电编码器检测。
- > 支持CAN总线控制、端子控制。
- > 高功率密度，高效率，高防护等级。
- > 完善的保护功能：输出短路、过流、过压、欠压、过热、过载、编码器断线等保护。
- > 输出力矩能力强，即使在弱磁区也有优异的力矩特性。
- > 防溜坡功能。

Features

Applicable to AC asynchronous motors and permanent magnet synchronous motors.

Types of water cooling and forced air cooling optional.

Resolvers and PE encoders signal input supported.

CAN bus communication control, and terminal control supported.

High power density, high efficiency, and high IP grade.

Overall protection: output short circuit, overcurrent, overvoltage, undervoltage, overtemperature, overload, encoder disconnected, etc.

Strong capability of torque output. Unabated torque output characteristics even at field weakening.

Anti-coasting function



铸铝
Cast aluminium



风冷
Forced air cooling



控制特性

Technical Features

过载能力 Overload capability	调速范围 Speed range	速度精度 Speed accuracy	速度波动 Speed ripple	转矩响应 Torque response	转矩精度 Torque accuracy	启动转矩 Starting torque
150% 1min, 180% 10s, 200% 0.5s	1:1000	±0.02%	±0.1%	<5ms	±5%	0Hz 200%

应用场合 Applications

- ◆ 乘用车 Passenger Vehicles
- ◆ 电动车 EV
- ◆ 混合动力汽车 HEV



产品特点

Products Features

ES101系列节能一体柜

ES101 Series Energy Saving Cabinet Drives

特点

- > ES101系列节能一体柜主要用于注塑机伺服节能，实现了压力闭环反馈控制，系统动态响应快，控制精度高。
- > 安装简单，节能效果好，维护成本低，性价比高。
- > 合理的结构设计，方便一体柜的日常保养和维护。
- > 工频/变频切换功能避免因驱动器故障而影响生产。
- > 通过智能压力闭环控制，控制注塑机电机在各个阶段的转速，确保油泵的出油量和注塑机的实际需求相一致，达到节能效果。
- > 快速的动态响应，提高生产效率：在流量和压力输出范围内，力矩快速建立和稳定输出，保证了加工工件的质量。
- > 一流的输出转矩控制和电压控制技术，0s启动无跳闸。

Features

- ES 101 Series Energy Saving Cabinet Drives are mainly used for injection molding machines, realizing pressure close-loop feedback control, with fast system response and high-precision control.
- Easier installation, better energy saving effect, lower maintenance cost,
- Considerate configuration makes maintenance easier.
- Grid/variable frequency switchable.
- Intelligent pressure close-loop control function makes motor speed changed accordingly, to get pump oil output exactly meet molding
- Fast response improves productivity: in the range of flow and pressure, a reliable output torque is established fast, ensuring high-quality of the products.
- Excellent output torque control and voltage control makes no trip even at 0s start.



应用场合 Applications

- ◆ 注塑机 Injection machines
- ◆ 压铸机 Die casting machines
- ◆ 中空吹塑机 Extrusion blow molding machines



产品特点

Products Features

GK1000系列AFE能量回馈型变频器

GK1000 Series AFE Energy Feedback AC Motor Drives

特点

- > 有源功率因数校正，电源端电流畸变率满足GB14549国标要求，实现真正的绿色能源。
- > 无要求电网相序，自动运行并网，四象限运行，实时实现母线能量回馈；特色的矢量控制算法，实现高转换效率。
- > 具有自动调节母线电压功能，保证所带负载转速和电流更加稳定，即使出现电网电压瞬间波动或负载突变，也能保证变频器不间断稳定运行，减少负载发热，延长负载寿命。
- > 便捷的无功调节，净化电网。
- > 完美的模块化设计，方便维护。

Features

Active power factor correction ensures that current distortion at power supply end meets Chinese national standard GB14549, realizing green energy feedback.

No requirement of power grid phase sequence, auto grid connection, four-quadrant operation, real-time bus energy feedback; advanced vector control algorithm ensures high efficiency of conversion.

Auto bus voltage adjustment function makes sure of stable current and load speed. Even if momentary grid voltage fluctuation or abrupt load change occurs, consecutive and stable drive running are assured, with lower load temperature rise and longer load life.

Reactive power adjustment produces extremely low harmonics to power grid.

Modularized design makes maintenance convenient.



技术参数

Technical Data

功率范围 Power rating	30kW~630kW
额定电压 Rated voltage	3相380V/400V/415V/440V/460V/480V Triphase 380V/400V/415V/440V/460V/480V
电源频率 Power frequency	50Hz/60Hz, 波动给范围±5% 50Hz/60Hz, tolerance ±5%
功率因数 Power factor	0.95(容性, 感性) ~1 0.95 (Advanced, Lagged) ~1
允许电压范围 Allowable voltage range	304V~506V
直流母线电压 DC bus voltage	450V~750V
输入电压容限 Input voltage allowance	电源电压可低40% 40% dropping at most
电流总谐波畸变率(THD) Current THD	≤2.5% (额定功率下) ≤2.5% (at rated Amps)
过载能力 Overload capability	150% 1min; 180% 10s; 200% 0.5s, 间隔10min 150% 1min; 180% 10s; 200% 0.5s, once per 10mins
防护等级 Protection grade	IP20

应用场合 Applications

◆ 传输链系统
Conveyor System

◆ 起重设备
Hoists & Cranes

◆ 直横剪纸机
Paper Shears

◆ 榨糖机
Sugar Mills

◆ 离心机
Centrifugal Machines

◆ 测功机
Eddy Current Dynamometers



应用领域 | Applications

用途 Applications

高速雕铣机
High-speed Engraving
And Milling Machines

加工中心
Machining Centers

车床
Lathes

铣床
Milling Machines

深孔钻
Deep-hole Drilling
Machines

磨床
Grinding Machines



特点

低速高转矩
低速高转矩输出，满足客户加工要求。

多种位置控制模式
定位、定向、零伺服和脉冲列跟随等多种高精度位置控制方式，满足多种加工工艺要求。

高精度的稳速控制
独特的弱磁控制算法，保证高低速同样的转速精度。

完善的保护功能
全方位的报警及保护功能；满足行业安全标准要求。

丰富的接口设计和参数拷贝功能
方便方案设计和设备调试，简化配套客户的工作。

规格齐全的主轴伺服电机，可定制非标电机
配合GTAKE主轴伺服电机，可取得更优的控制效果。

Features

Adequate output torque at low frequency
Adequate output torque meets metal processing requirement at low speed.

Position control modes programmable
A variety of position control modes programmable: feed, orientation, zero servo, and pulse train.

High precision speed control
Field weakening control ensures the same speed stabilization no matter in high speed or low speed running.

Overall protection
Overall fault prompts, intelligent protections make the drives meet all relative safety requirements.

Abundant interfaces and parameter copy function
Easy commissioning and solution design.

Spindle servo motors of complete models, with customized motor available

Excellent control effects by working with GTAKE spindle servo motor.



应用领域

Applications



用途 Applications

塔式起重机
Tower Cranes

桥式起重机
Bridge Cranes

港机
Port Cranes

电动葫芦
Electric Hoists

电动绞车
Electric Winches

矿井提升机
Mine Hoists

卷扬机
Winches

施工升降机
Construction Hoists

特点

高起动转矩，响应快

无PG矢量控制0.25Hz达到180%输出转矩，<10ms的转矩响应时间；有PG矢量控制0Hz可提供200%输出转矩，<5ms的转矩响应时间；防止低速时因转矩不足，而导致负载滑落等事故。

双电机间切换

可分别设置两组电机参数，应用于1台变频器驱动行走和平移2个不同电机的场合。

抱闸控制功能

针对升降行业的抱闸逻辑控制及监控功能，更灵活地实现起重机平稳启停，有效防止物体的滑落。

完善的保护功能

全方位的报警及保护功能；满足行业安全标准要求。

Features

Sufficient start torque, fast response

180% output torque at 0.25Hz, <10ms torque response time under speed-sensorless control pattern; 200% output torque at 0Hz, <5ms torque response time at speed-sensor control pattern. Slip accidents are prevented as the result of in-sufficient torque at low frequency.

Two motor profiles programmable

Two motor parameters are programmable respectively, fit for cases with two motors controlling two independent organs in a system.

Contracting brake control

Contracting brake control function specific for hoisting industry, assures smooth start/stop, and avoids hookslip accident.

Overall protection

Overall fault prompts, intelligent protections make the drives meet all relative safety requirements.



应用领域 | Applications



卷绕机械

Winding & Unwinding

特点

灵活的收放卷方式

多种卷径计算方式，对于中心收放卷场合，能实现恒线速度、恒张力控制。

符合行业工艺要求的功能设计

摩擦补偿和惯量补偿功能，对于不同机械的补偿调整，保证加减速时张力保持一致。

Features

Intelligent process control

Dynamical coil diameter calculation methods realize stabilized linear speed, and constant tension control to centre winding, unwinding applications.

Specific functions

Friction compensation and inertia compensation ensures constant tension in process of Accel/Decel with different mechanical loads.

完美的成型控制

多种方式的张力锥度控制，保证收卷轴良好的成型效果。

完善的保护功能

全方位的报警及保护功能，满足行业安全标准要求。

丰富的接口设计和参数拷贝功能

方便方案设计和设备调试，简化配套客户的工作。

多种张力控制方式选择

张力开环、闭环、速度、转矩多种控制方式供客户选择，可满足多种场合应用。

Molding control

Tension taper control guarantees impeccable products.

Overall protection

Overall fault prompts, intelligent protections make the drives meet all relative safety requirements.

Abundant interfaces and parameter copy function

Easy commissioning and solution design.

Multiple tension control methods optional

Open-loop, closed-loop, speed, and torque control methods available for customers to meet various applications.

用途 Applications

印刷机械
Printing Machines

包装机械
Packing Machines

拉丝机
Wire Drawing Machines

吹膜机
Plastic Puffing Machines

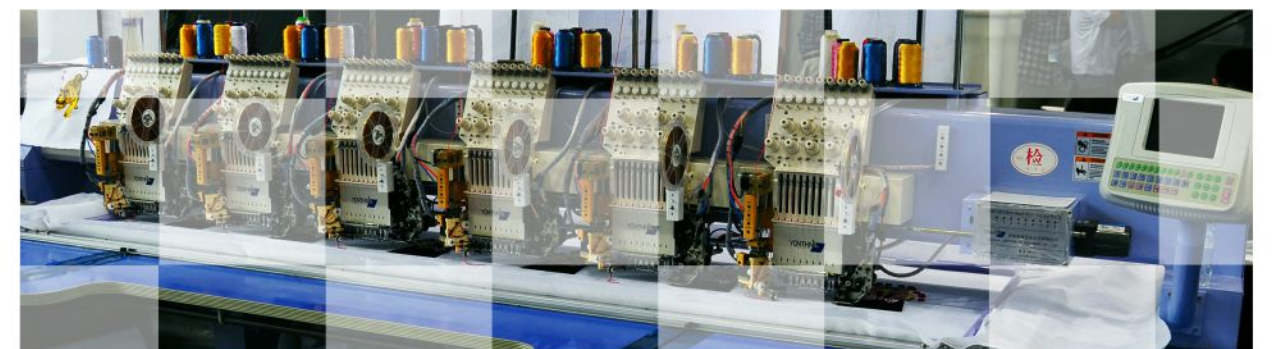

应用领域 | Applications

特点

稳速精度高、运行电流小

先进的矢量控制算法，确保运行时稳速精度高，电流波动小，更有效地实现节能。

高精度、高响应PID控制

独特的高精度、高响应的PID控制模块，确保了升压和泄压过程中压力响应快(<25ms)；保压过程中压力稳定性强(压力波动<0.5kg)。

完美的硬件和结构设计

硬件的耐温点高，适用于注塑机高温作业；专业的防护，有效避免灰尘、油污对驱动器的破坏。

Features

Precise speed, low current

Advanced vector control pledges precise speed, small current fluctuation, realizing well energy saving effect.

Precise, fast responded PID control

Precise, fast responded PID control pledges fast pressure response (less than 25ms) in process of pressure boosting and dropping, also stable pressure in pressure holding.

Hardware and structure

Better heat-resistant hardware, higher IP grade.

用途 Applications

注塑机

Injection Molding Machines

工程机械

Construction Machineries

中空吹塑机

Blow Moulding Machines

压铸机

Die Casting Machines

鞋机

Shoemaking Machines

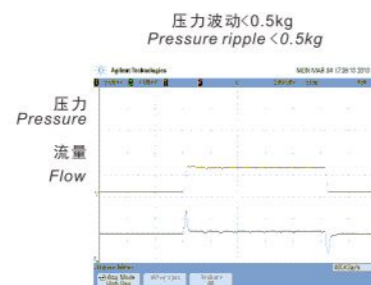

保压阶段
Pressure holding

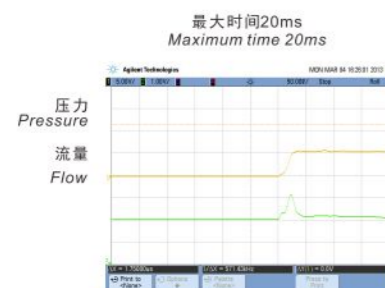

压力上升阶段
Pressure boosting

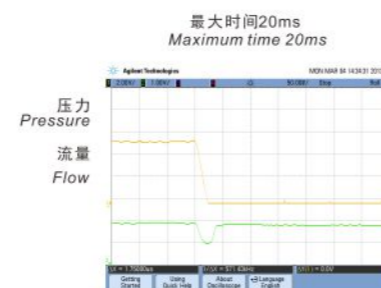

压力下降阶段
Pressure dropping



Oil Pump Servo Drives

应用领域 | Applications



空压机驱动

Air Compressor Drives

特点 Features

气压稳定

通过实时监测供气压力，实现变频恒压控制。精准控制输出压力；压力带维持在0.1bar内，无需配置大的储气罐，压力不会超过所需值，无能源浪费。

Stable air pressure

Realize variable frequency and constant pressure control by real-time monitoring of the air supply pressure. The output pressure is precisely under control. Pressure belt is within 0.1 bar. No need to configure large air tank and the pressure will not exceed the required value, without energy waste.

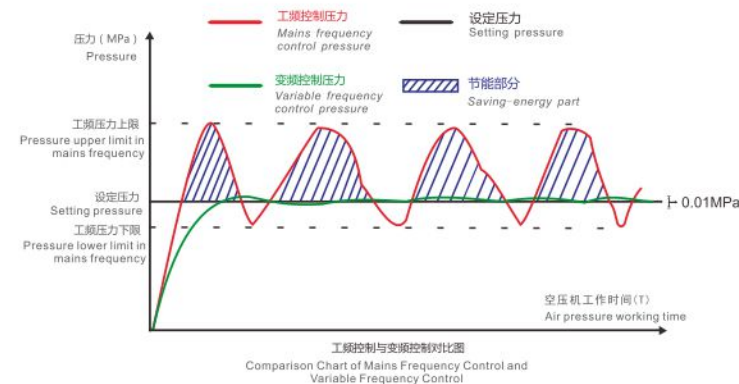

启动平稳无冲击

无启动电流峰值，启动电流最大在额定电流的1.2倍以内，减小对机械冲击，可以延长压缩机整体的使用寿命。按实际所需传递扭矩，无多余能源浪费。

Smooth start, impact-free

No starting current peak, maximum starting current is within 1.2 times of the rated current, which reduces mechanical shock, extends the overall life of the compressor, and transmits required torque, no extra energy wasted.

节能、高效率、噪音低

最大限度的减少空载率，通过控制主机转速来把压力恒定在用户所需压力，提高生产效率和产品质量，同时达到节能的目的。

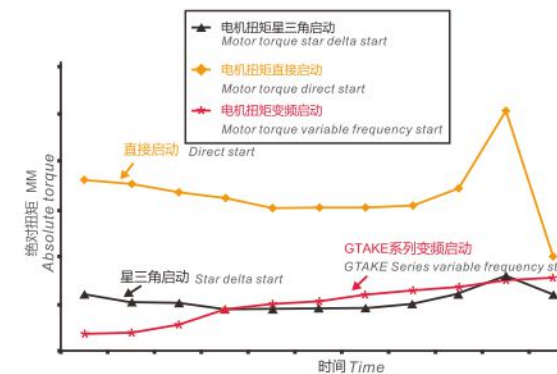

支持同步、异步电机开环矢量控制，多种控制方案选择提供同步电机、异步电机、一体机、空压机控制器等多种控制方案供客户选择。



Energy saving, high efficiency, low noise

Reduce no-load rate to a maximum extent, stabilize the pressure by controlling the main motor revolving speed, thus improving production efficiency and product quality, and saving energy.

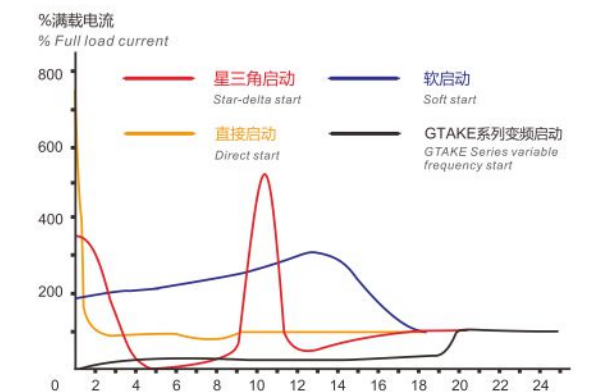

Multiple control schemes

Supports open loop vector control for synchronous, and asynchronous motor, provides multiple optional control schemes for customers.

公司荣誉 | Enterprise Honours



数十项专利成果
Patents



数十项专利成果
Patents



ISO9001/TS16949



数十项专利成果
Patents



国家高新技术企业;
National High-tech Enterprise



GOST



TUV



CE

服务网络 | Service Network



吉泰科公司注册于南通，总部位于深圳；在南通、新疆建立了库存中心，覆盖全国市场。

在国内有22个办事处，陆续会增设新的办事处、联保中心、备件中心；营销服务网络遍布全国；我们凭借多年来在工业自动化行业领先的驱动器技术以及丰富的经验，为客户提供全方位的配套驱动解决方案。

Nantong is the registered address of GTAKE, while the headquarter is located in Shenzhen. Inventory centers have been set up in Nantong and Xinjiang, covering all domestic territories.

There are 22 branch offices spread across China so far, and we are setting up more new offices, warranty service centers, spare part centers, to render better services nationwide. Thanks to our leading drive technology in automation industry, and a great deal of field experience, complete drive and control solutions are provided for our customers worldwide.

